

owner's manual

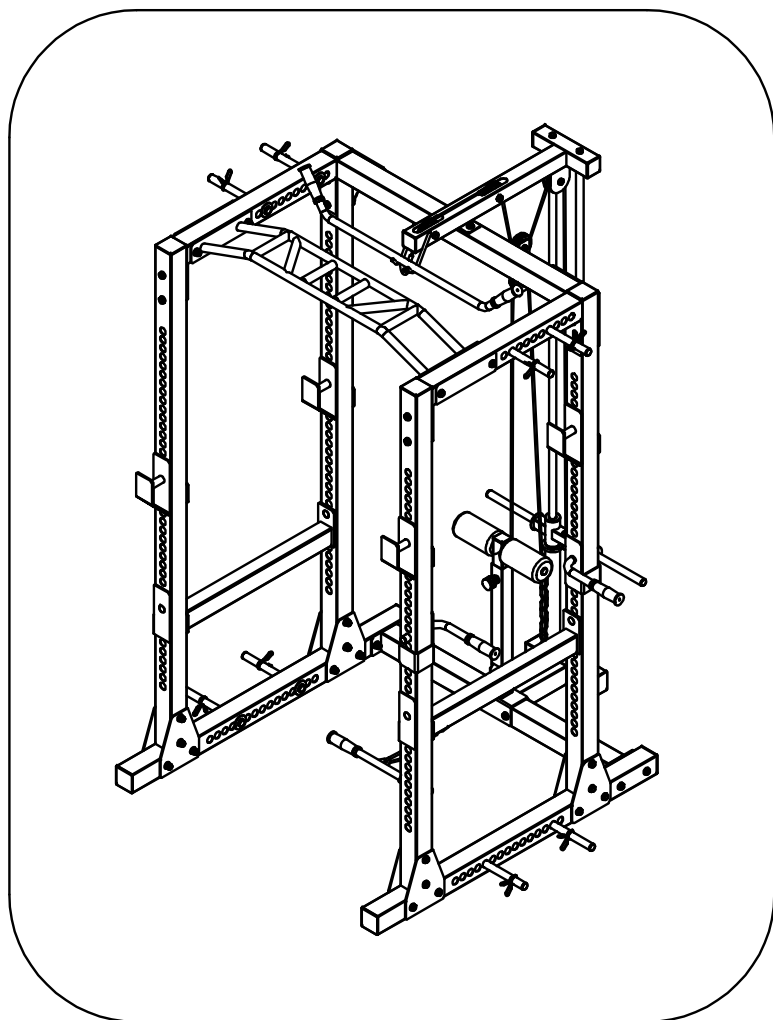

Important Safety Information

Prior to assembly, remove components from the box and verify that all the listed parts were supplied.

NOTE: Hand tighten bolts and nylon until machine is fully assembled.

! CAUTION

Read all precautions and instructions in this manual before using this equipment.

WARNING!











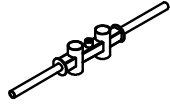

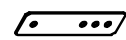

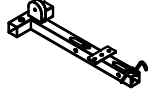

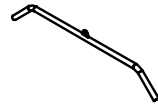

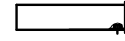
Before using this unit or starting any exercise program, consult your physician. This is especially important for persons over the age of 35 and/or persons with pre-existing health problems. The product LP assumes no responsibility for personal injury or property damage sustained by or through the use of this product.

It is the owner's responsibility to ensure that all users of this unit have read the owner's manual and are familiar with safety information and precautions.

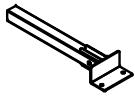
SAFETY PRECAUTIONS

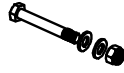
- This unit should only be used on a level surface and is intended for indoor use only. We recommend an equipment mat be placed under the unit to protect the floor or carpet and for easier cleaning.
- Wear comfortable, good-quality walking or running shoes and appropriate clothing. Do not use this unit with bare feet, sandals, socks or stockings!
- Always examine your unit before using to ensure all parts are in working order.
- Do not leave children unsupervised near to the unit.

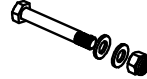

PART		LIST					
	1		2		3		4
1 PC	1 PC	2 PCS	2 PCS	1 PC	1 PC	1 PC	1 PC
	5		6		7		8
1 PC	1 PC	1 PC	1 PC	1 PC	1 PC	1 PC	1 PC
	9		10		11		12
2 PCS	2 PCS	6 PCS	4 PCS	2 PCS	2 PCS	2 PCS	2 PCS
	13		14		15		16
5 PCS	4 PCS	1 PC	2 PCS	1 PC	2 PCS	2 PCS	2 PCS
M10*80 bolt	M10*80 bolt, nut, washer	M10*45 bolt, nut, washer	M10*20 bolt, washer				
	17		18		19		20
2 PCS	2 PCS	4 PCS	2 PCS	2 PCS	2 PCS	2 PCS	2 PCS
M12*100 bolt, nut, washer	M12*95 bolt, nut, washer						
	21		22				
2 PCS	2 PCS	2 PCS	2 PCS				

The composing of accessories

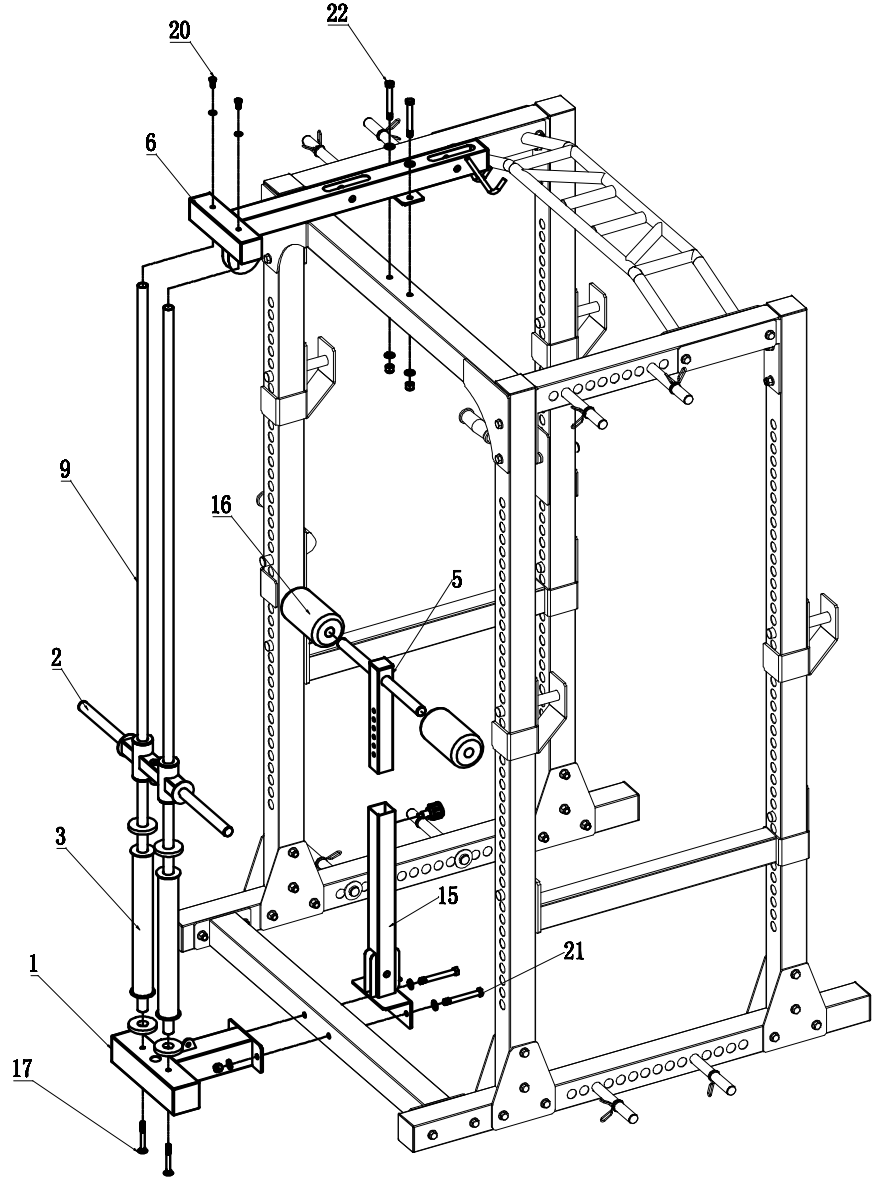

※ there is anti-slip nylon damp please strenthen it in tool.

The composing of accessories

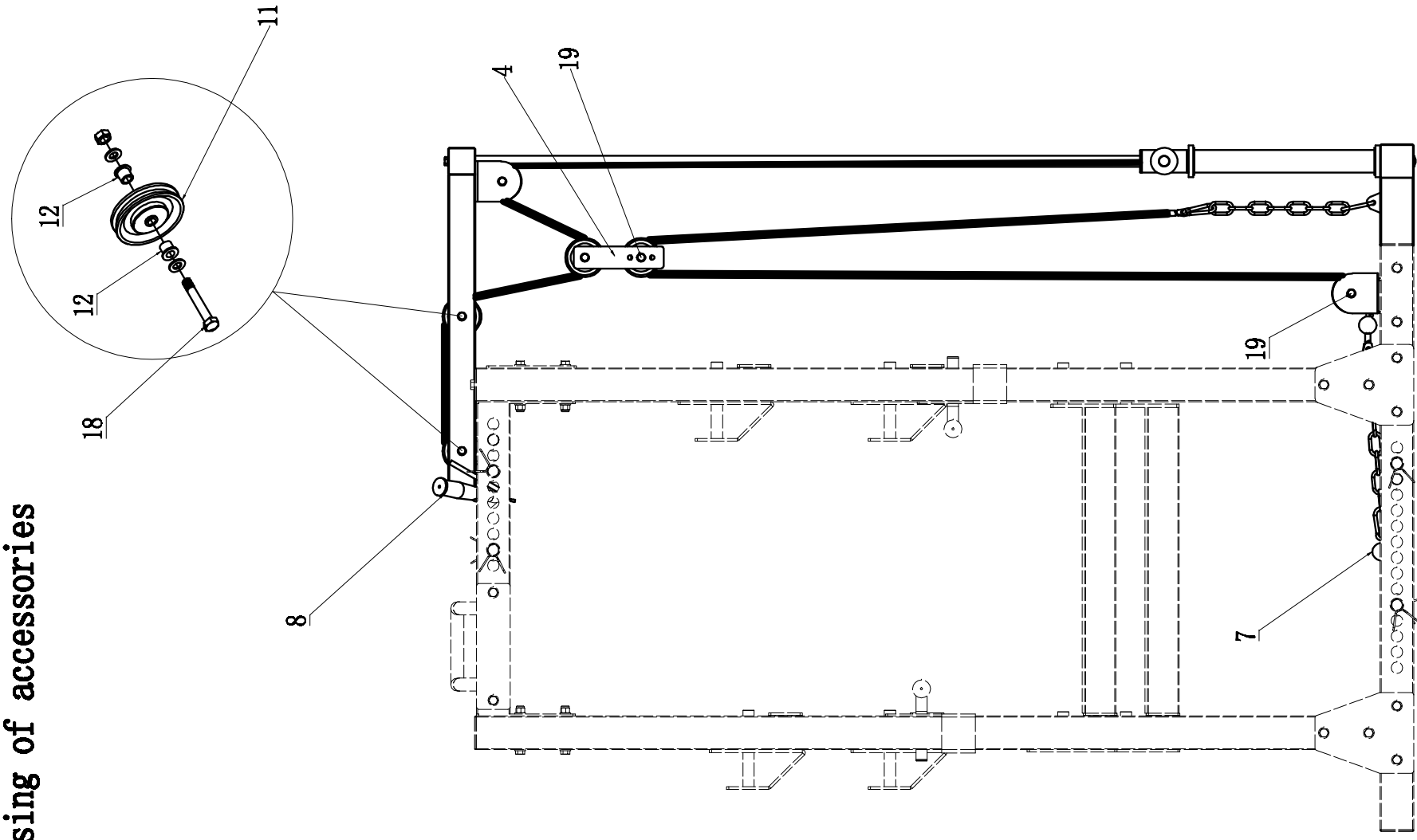

※ there is anti-slip nylon damp please strenthen it in tool.