



RT500

Treadmill

After-Sale Service Manual



Contents

I. Introduction	4
1. Main components	4
2. Internal frame diagram	5
3. Working principle	6
II. Installation	7
1. Packing list	7
2. List of fasteners	8
3. Installation steps	9
III. Accessories	17
1. Exploded view	17
2. List of accessories	21
IV. Application	25
1. Precautions	25
2. Warming-up exercise	29
3. Console parameter specification	30
V. Parameter settings	39
1. Inch/ metric interchange	39
2. Console parameter settings	40
VI. Maintenance	41
1. Main electrical connection diagram	41
2. Maintenance tools	43
3. Fault and maintenance instructions	44
1. Console displays ER01	44
2. Console displays ER02	46
3. Console displays ER03	47
4. Console displays ER04	49
5. Console displays ER05	50
6. Console displays ER06	50
7. Console displays ER07	52
8. Console displays nothing	54
9. Console has display, but the treadmill cannot start	57
10.1 Console has no power supply, but the main board power supply is normal	59
10.2 Belt jitter	63
10.3 fault with incline motor	65

Contents

10.4 Over-current protection -----	67
4. Equipment maintenance -----	68
5. Replacement of main components -----	70
1. Replacement of belt -----	70
2. Replacement of wedge belt -----	74
3. Replacement of belt drive motor-----	76
4. Replacement of incline motor-----	77
5. Replacement of front wheel components -----	79
6. Replacement of rear wheel components -----	79
7. Replacement of console board -----	80



Impulse (Qingdao) Health Tech Ltd. reserves the right to interpret and correct the misprints, if any, as stated in this instruction. Any changes in the documents resulting from the product upgrade and improvement shall be made without prior notice. The amended information shall be included in the new instructions directly.

Main components

RT500 Treadmill is mainly composed of console, cup holder, handle, upright, motor, incline motor, running belt, running board, wheel, axle tube and deck frame, etc.



Introduction

Internal frame diagram



Reverse side frame diagram of deck frame



Interior diagram of motor cover



diagram of intermediate adapter plate

Working principle

The treadmill is powered on to transmit signal instruction by operating the console via the console wire to the inverter, adjusting the frequency required for the desired speed to rotate the motor, thereby controlling the rotational speed of the running belt for use.

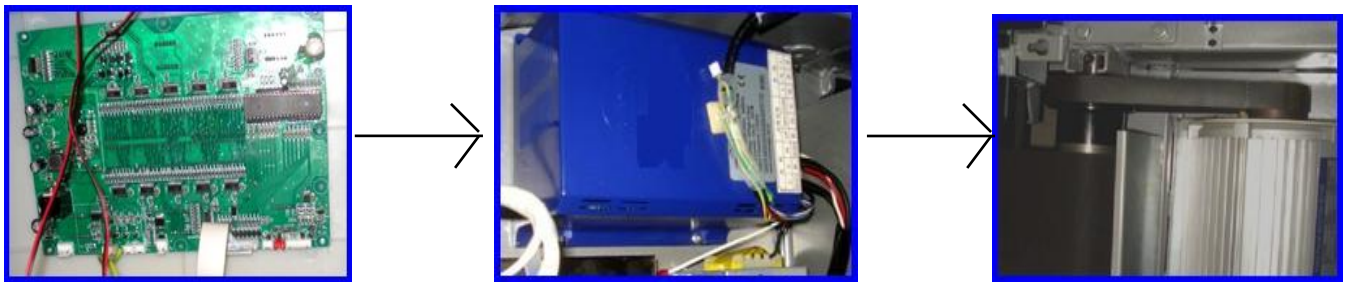

The treadmill is powered on to transmit signal instruction by operating the console to the inverter, which is output to the incline motor, the potentiometer in the incline motor feeds back the incline height of the incline motor in the form of analog quantity to a scale to the inverter, thus achieving the control of the incline height.



Packing list

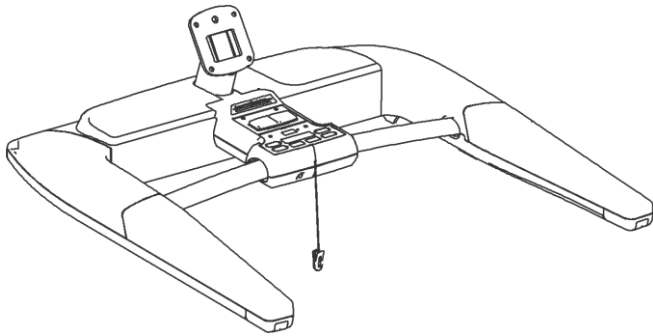

CONSOLE FRAME

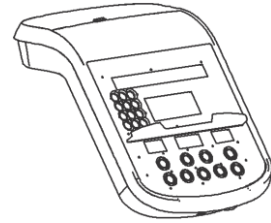

CONSOLE

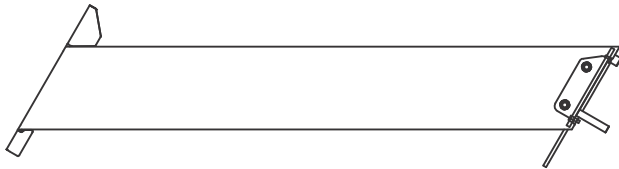

LEFT UPRIGHT



HARD WARE

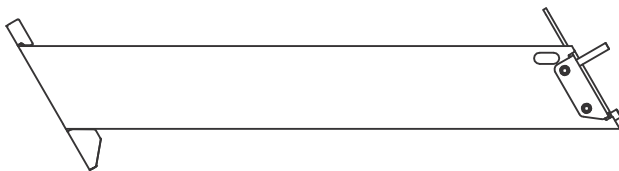

RIGHT UPRIGHT



OWNER'S MANUAL



BOLT COVER

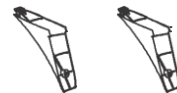

ROUTING COVER

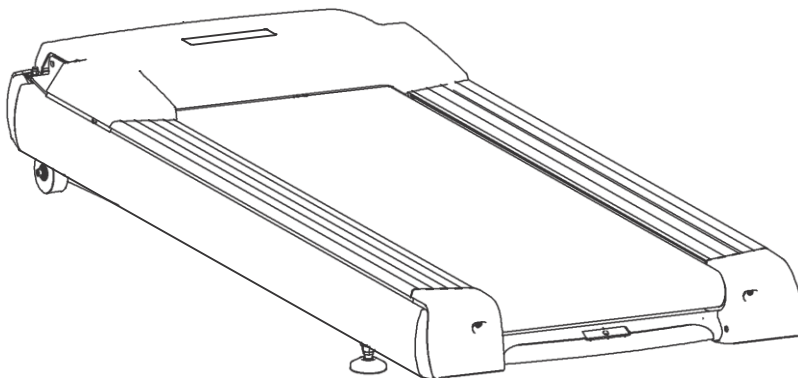

DECK FRAME



CONSOLE BACKSHIELD

POWER WIRE, THE FIXED
PLATE OF POWER WIRE

POWER WIRE, THE FIXED
PLATE OF POWER WIRE

Installation hardware

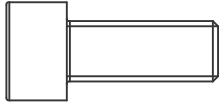

four M8*20 Socket Head Cap Screw (#93)

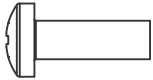

two M5*15 Philips Screw (#84)

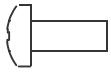

two M4*10 Philips Screw (#174)

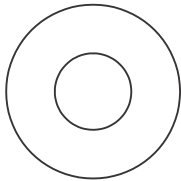

ten $\Phi 11 * \Phi 23 * 2$ Washer (#183)

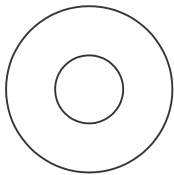

twelve $\Phi 9 * \Phi 22 * 2$ Washer (#208)



two M10 Locknut (#206)

Installation

Installation step 1

Open the packaging box and take all the things out of it, then move the deck frame to a level place.

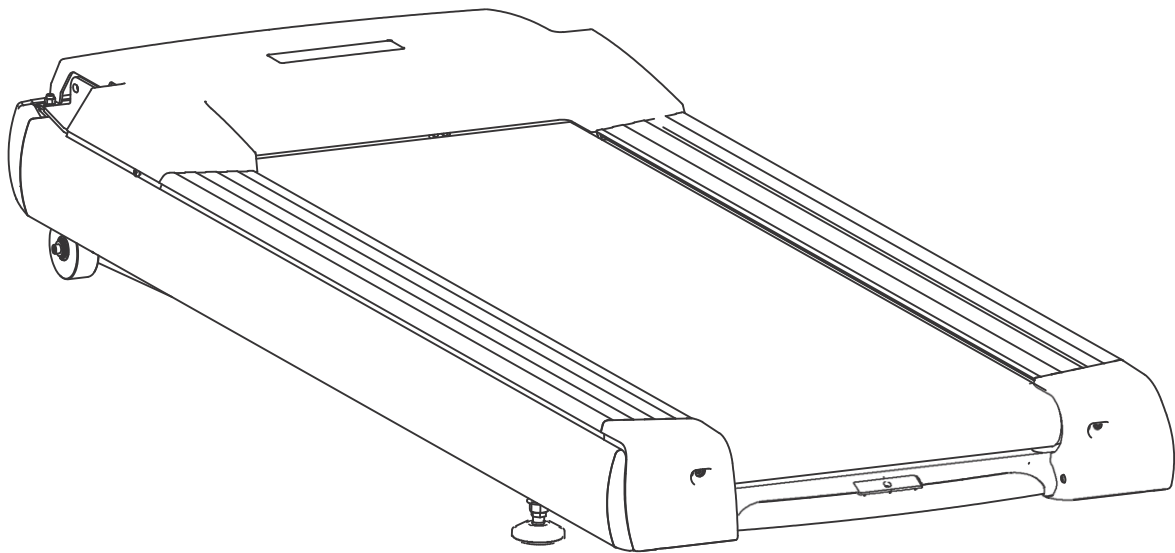

Installation

Installation step 2

1. Remove the Motor Cover (#20), use the following parts:
four M6*20 Socket Head Cap Screw (#180)
2. Then you need to take down the nuts that fixing the left upright and right upright, use the following parts:
four M10 Nut
two $\Phi 11*\Phi 23*2$ Washer

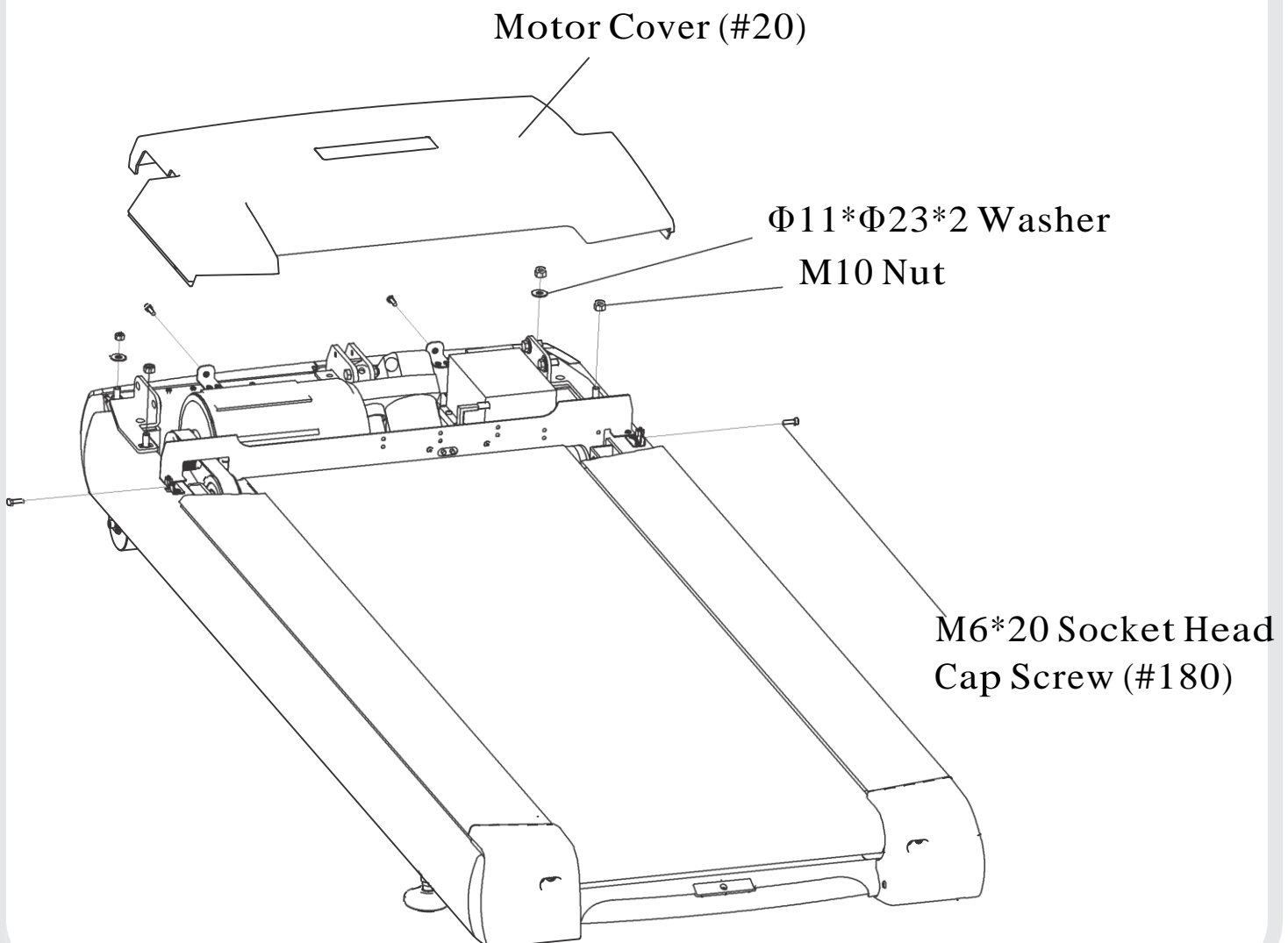

Installation step 3

Attach the left upright (#2) and the right upright (#3) to the mainframe use the following parts:

four M10*25 Hex Bolt (#169)

six $\Phi 11*\Phi 23*2$ Washer (#183)

two M10*165 Hex Bolt (#190)

two M10*180 Hex Bolt (#191)

two M10 Locknut (#206)

four $\Phi 10$ Serrated Lock Washers (#261)

NOTE: BEFORE YOU DO THIS STEP, PLEASE PUT THE CONSOLE WIRE DOWN (#215) THROUGH THE RIGHT UPRIGHT.

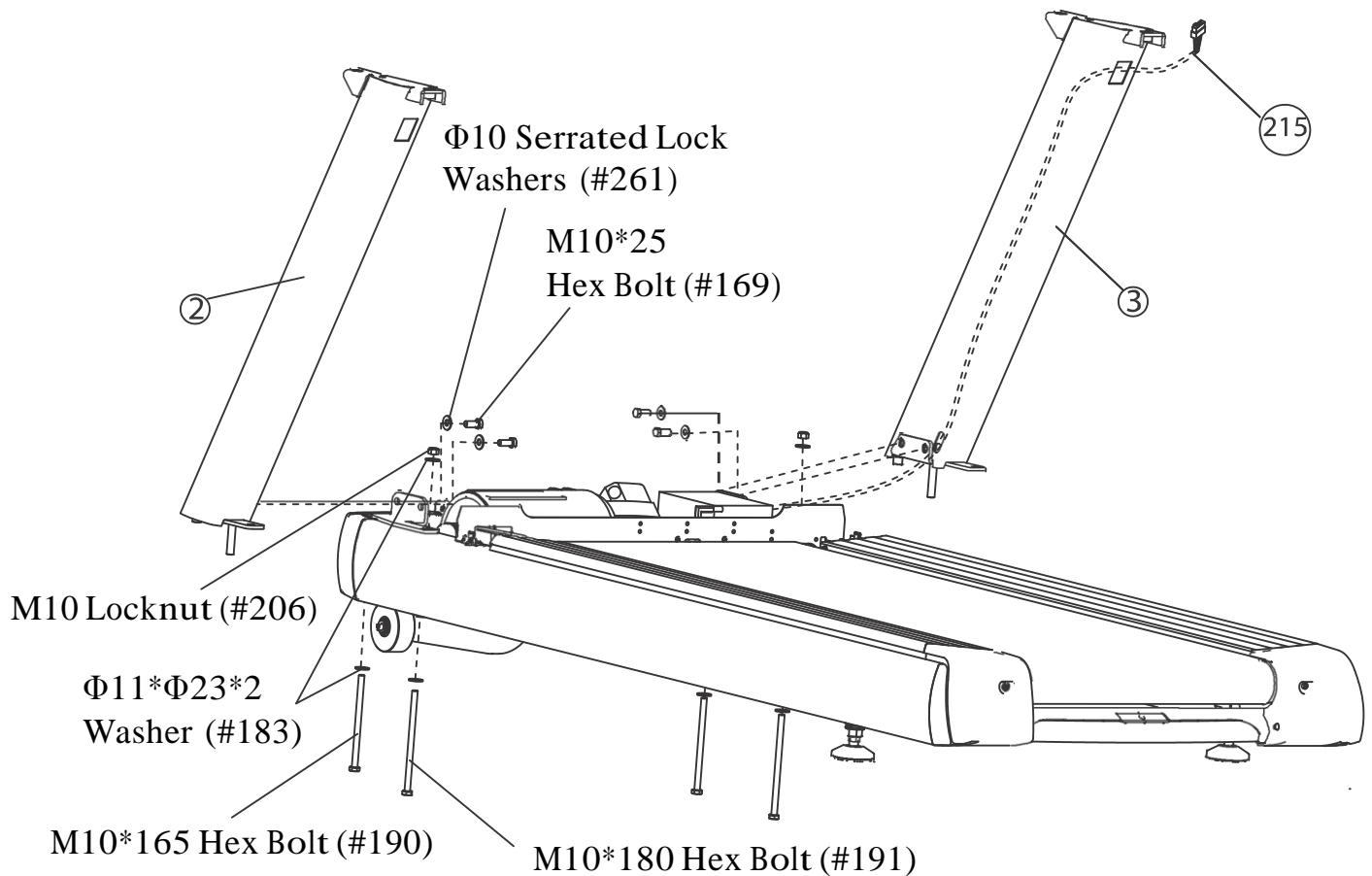

Installation step 4

Fix the console assemble onto the uprights using:

four M8*30 Socket Head Cap Screw (#188)

four $\Phi 9*\Phi 22*2$ Washer (#97)

four $\Phi 8$ Serrated Lock Washers (#262)

Link the Console Wire Up (#124) to the Console Wire Down (#215).

NOTE: DON'T DAMAGE TO THE CONSOLE LINK WIRE WHEN INSTALL THE CONSOLE ASSEMBLY.

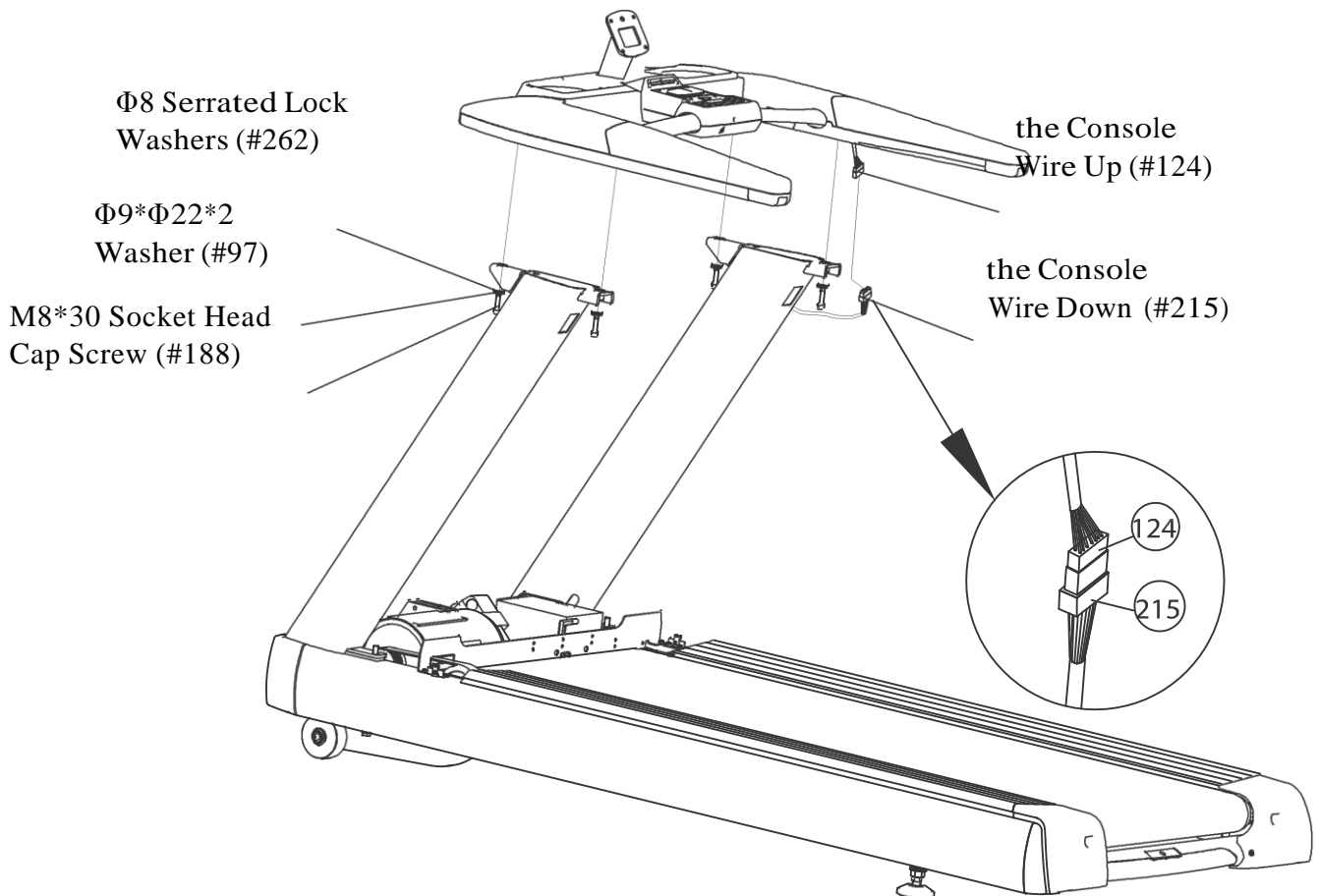

Installation step 5

Install the Left Wire Cover (#43), the Right Wire Cover (#44), the Left Bolt Cover (#45), the Right Bolt Cover (#46) under the console frame. Use the following parts:
four M5*20 Philips Screw (#85)

NOTE: YOU MUST PUT LOCK GROOVE IN THE SQUARE HOLE ON THE TUBE WHEN INSTALLING THE COVERS.

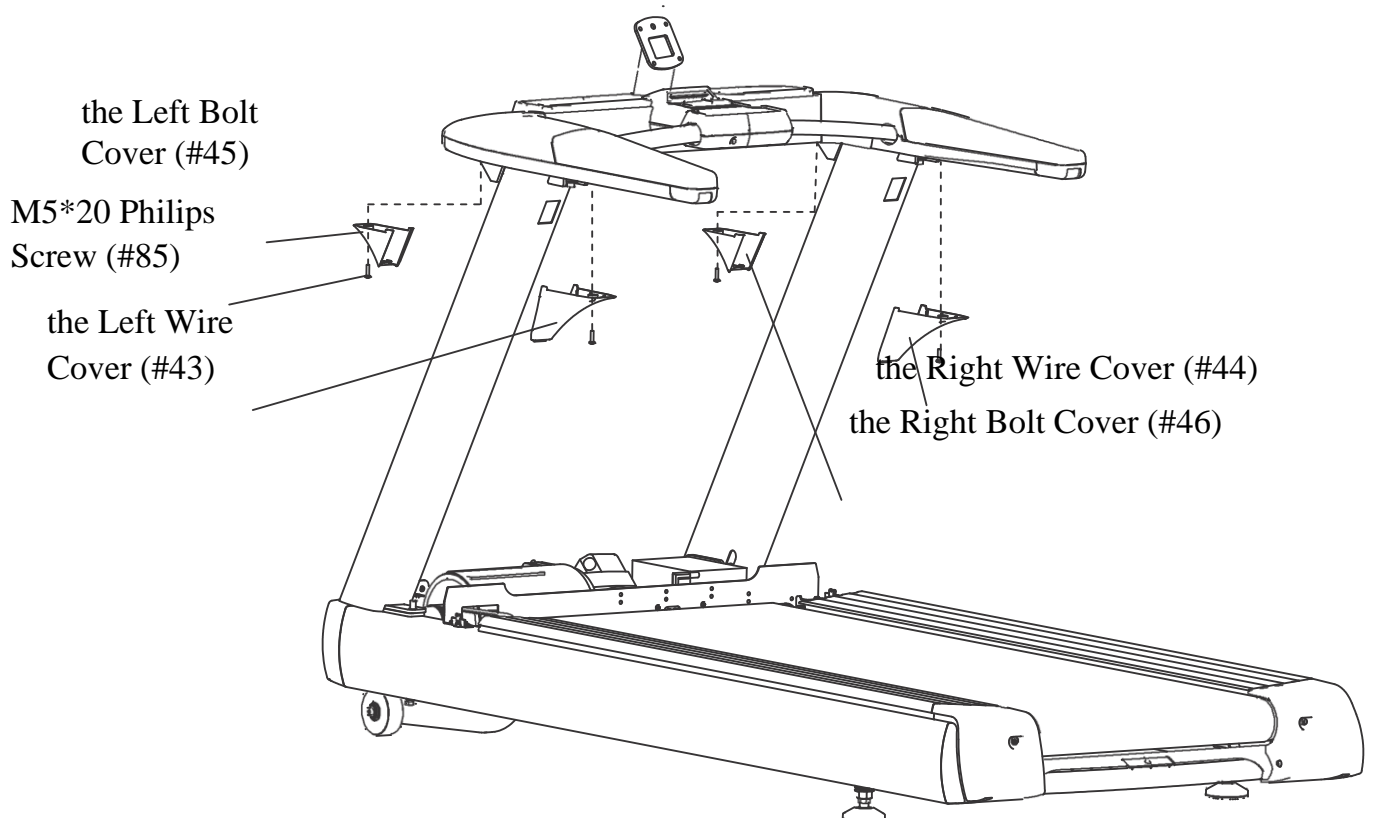

Installation step 6

Reinstall the motor cover (#20). Tighten the bolts that fix the left upright and right upright. Use the following parts:
four M6*20 Socket Head Cap Screw (#180)

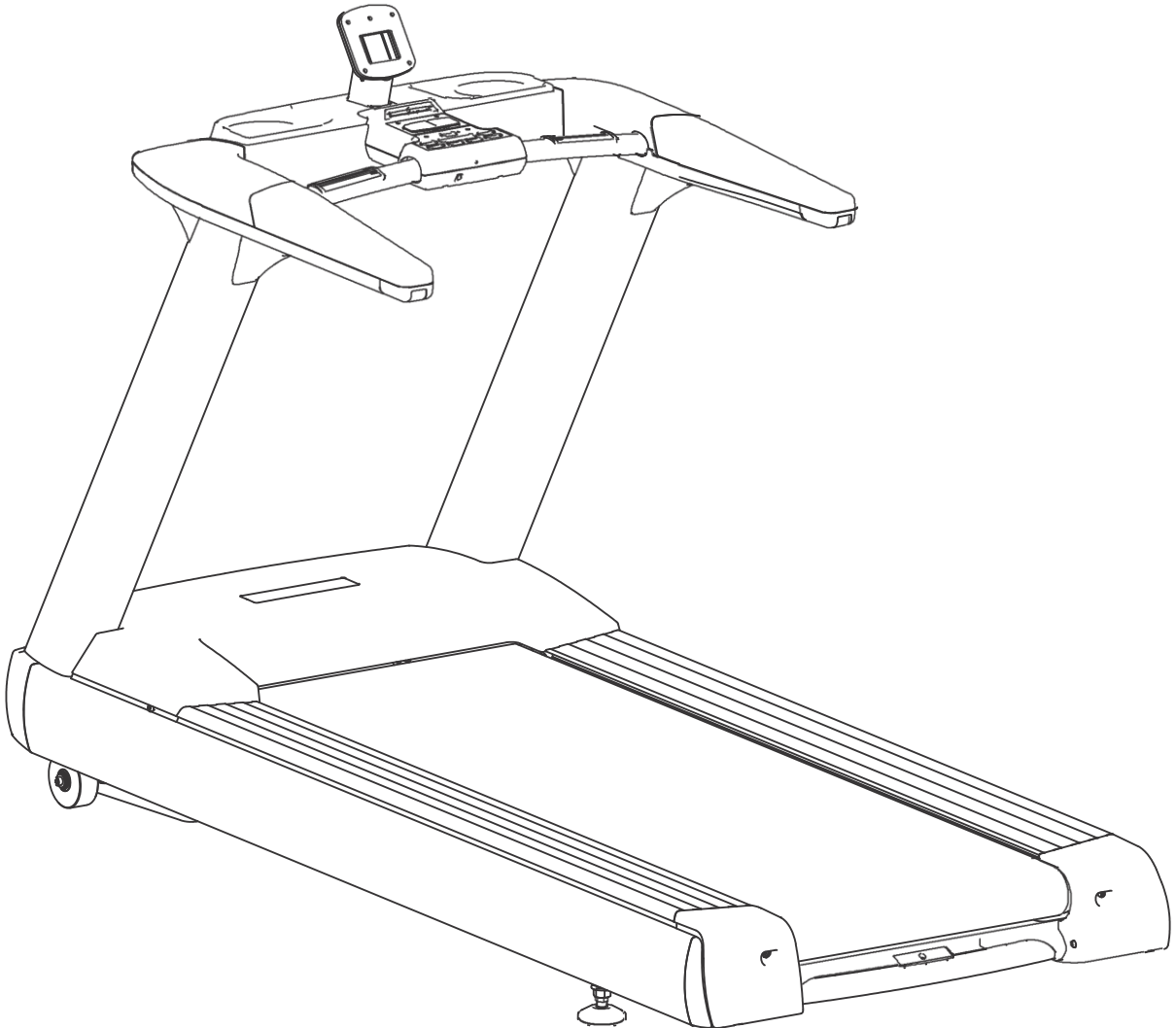

Installation step 7

Install the console (#80) on the console frame (#1). Link up the console wire. use the following parts:

four M8*20 Socket Head Cap Screw (#93)

four $\Phi 9*\Phi 22*2$ Washer (#97)

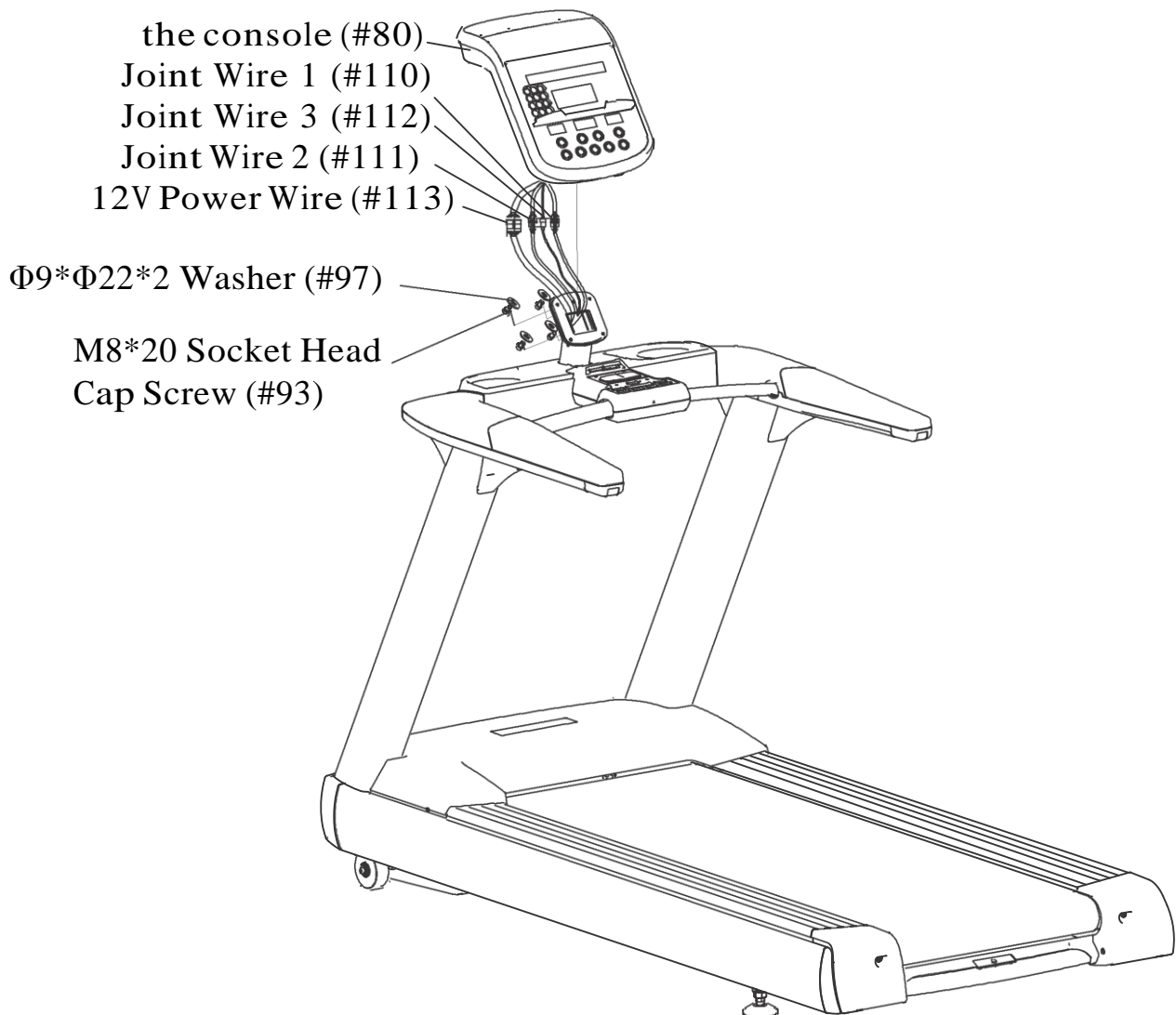

Installation step 8

Install the Console Back Cover (#64) on the console frame (#1). Install the Power Wire (#226) and fix Power Wire Fixing Plate (#193) on the bottom of the Power Wire. Use the following parts:

two M5*15 Philips Screw (#84)

two M4*10 Philips Screw (#174)

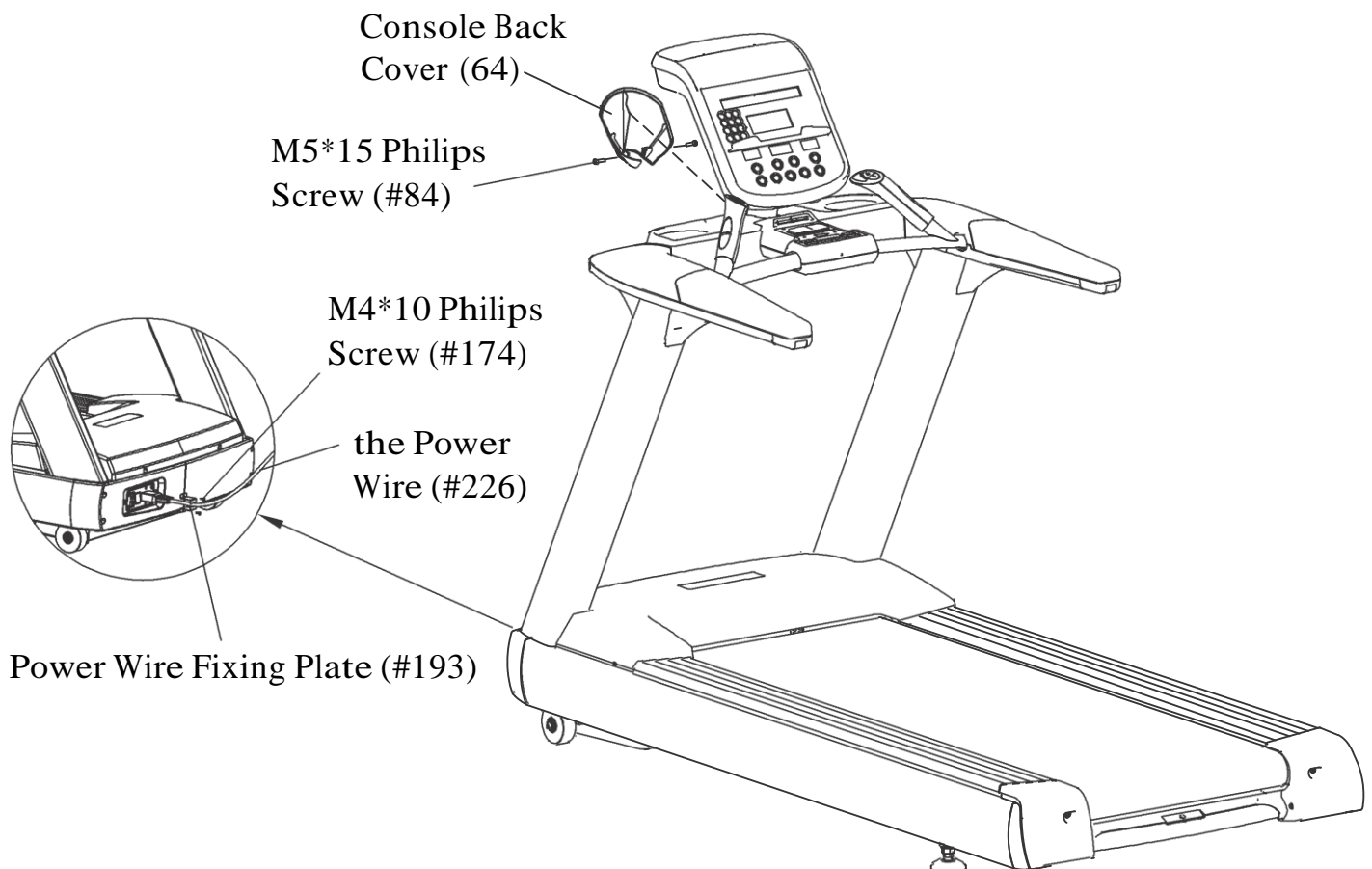

Exploded view (110V)

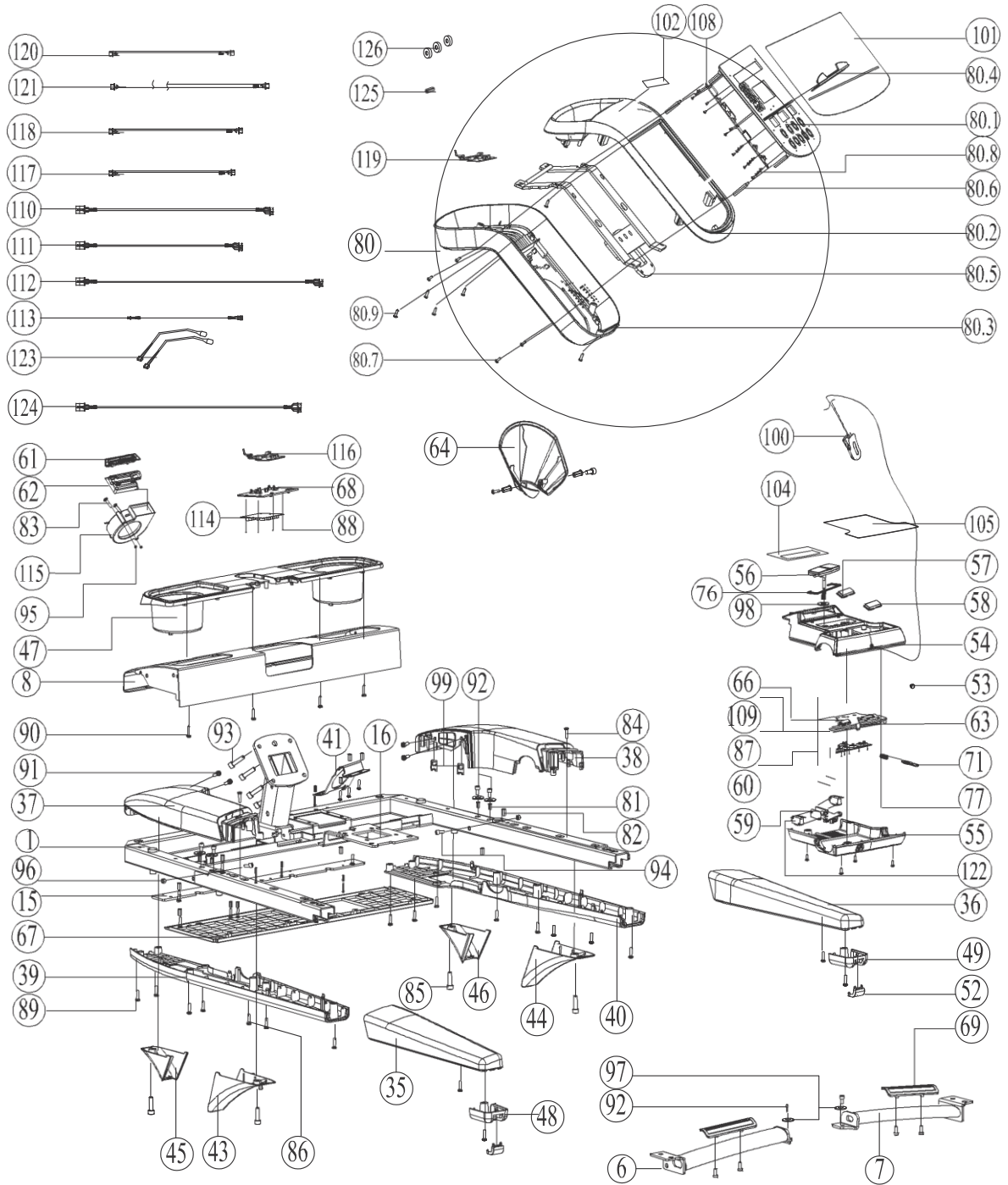

Exploded view (220V)

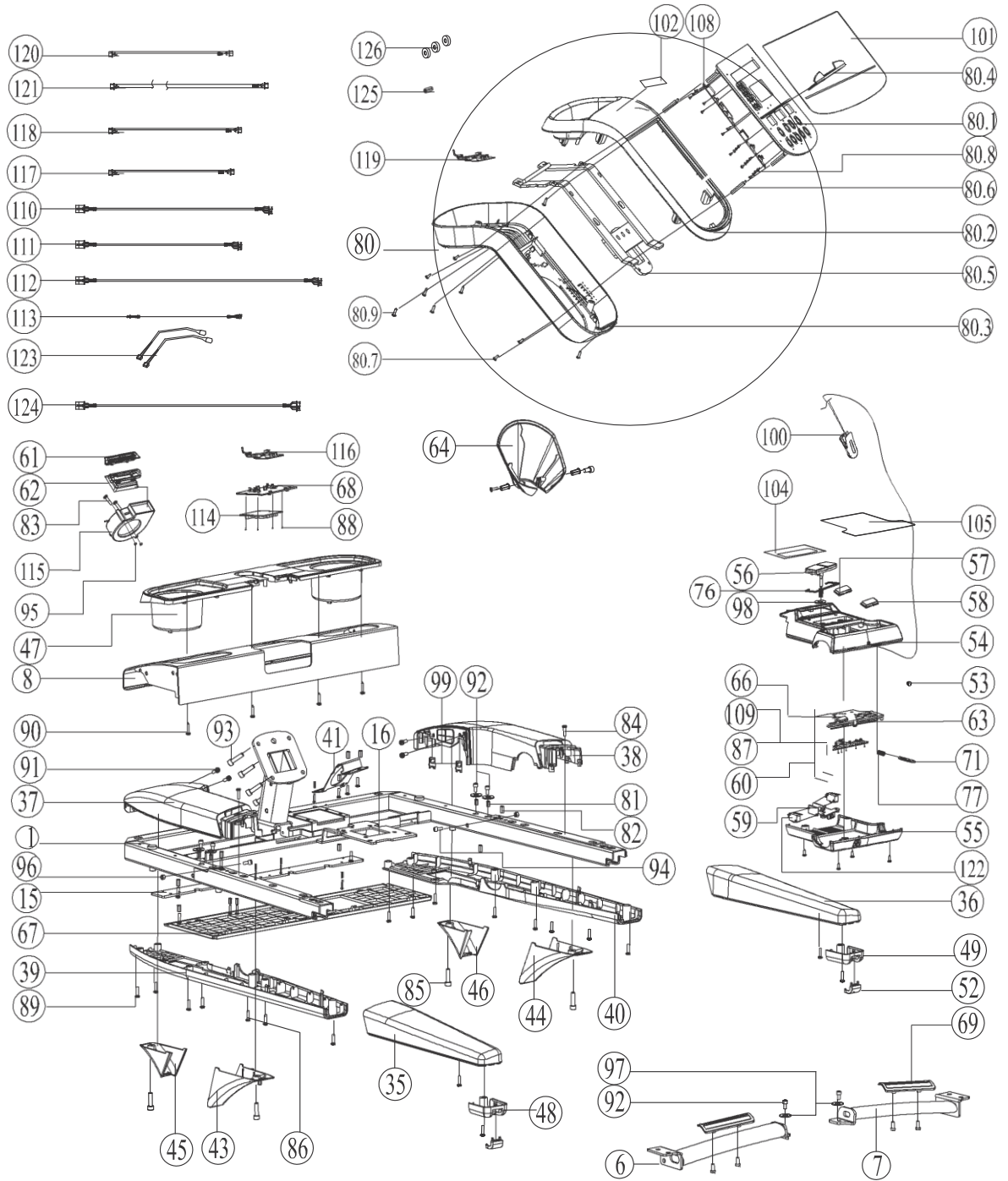

Parts list 110V

Item No.	Description	QTY	Item No.	Description	QTY
1	Console Frame	1	53	Earphone Hole Plug	1
2	Left Upright	1	54	A-Zone Up Cover	1
3	Right Upright	1	55	A-Zone Down Cover	1
4	Deck Frame	1	56	Emergency Switch Key	1
5	Elevating Frame	1	57	Fan Key	7
6	Left Handle Frame	1	58	Cool Down\Pause Key	1
7	Right Handle Frame	1	59	Limit Key Fixing Plate	1
8	Console Plate Frame	1	60	Emergency Switch Baffle	1
9	Motor Fixing Plate	1	61	Air Grid	1
10	Dust Proof Plate	1	62	Air Up Cover	1
11	Front Motor Cover Fixing L Plate	2	63	A-Zone Insert	1
12	Motor Cover Fixing L Plate	2	64	Console Back Cover	1
13	Elevate Rotational Sleeve	2	66	Start Key	1
14	Front Cover Fixing Plate	2	67	Console Bottom Plate	1
15	Console Linked Plate	1	68	Switch Fixing Plate	1
16	Middle Z Fixing Plate	1	69	Pulse Fixing Plate	2
17	Running Belt	1	70	Pulse Sheet	4
18	Controller U Fixing Plate	1	71	Nylon Shaft	1
19	Elevating Frame Fixing Shoulder Bolt	2	72	Left Side	1
20	Motor Cover	1	73	Right Side	1
21	Left Front Decorative Cover	1	74	Left Steel Side	1
22	Right Front Decorative Cover	1	75	Right Steel Side	1
24	Running Board	1	76	Reposition Rack	1
25	Left Rear Adjusting Seat	1	77	Restrict Spring	1
26	Right Rear Adjusting Seat	1	80	Console Component	1
27	Left Rear Decorative Cover	1	81	Flat Head Hexagon Riveted Nuts M8	4
28	Right Rear Decorative Cover	1	82	Countersunk Head Hexagon Riveted Nuts M5	18
29	Middle Protective Cover	1	83	Phillip Screw M4*40	2
30	Switch Cover	1	84	Phillip Screw M5*15	39
32	Front Roller	1	85	Phillip Screw M5*20	4
33	Rear Roller	1	86	Phillip Screw M5*35	6
35	Left Handle	1	87	Phillip Screw St2.9*6.5	17
36	Right Handle	1	88	Phillip Screw St2.9*9.5	4
37	Console Left Up Cover	1	89	Phillip Screw St4.2*13	9
38	Console Right Up Cover	1	90	Phillip Screw St4.2*50	4
39	Console Left Down Cover	1	91	Hex Head Bolt M6*15	4
40	Console Right Down Cover	1	92	Socket Head Cap Screw M8*15	4
41	Fan Fixing Plate	1	93	Socket Head Cap Screw M8*20	8
43	Left Routing Cover	1	94	Socket Head Cap Screw M8*55	2
44	Right Routing Cover	1	95	Hex Nut M4	2
45	Left Bolt Cover	1	96	Locknut M8	2
46	Right Bolt Cover	1	97	Washer $\Phi 9 \times \Phi 22 \times 2$	14
47	Cup Holder	1	98	Split Damping Ring $\Phi 9$	1
48	Left Signing Light Fixing Plate	1	99	Clip Nut	4
49	Right Signing Light Fixing Plate	1	100	Safe Key Clamp	1
52	Console Signing Light Cover	2	101	Console Overlay	1

Parts list110V

Item No.	Description	QTY	Item No.	Description	QTY
102	Sign Paster	1	178	Phillip Screw M6*30	6
104	A Zone Up Overlay	1	179	Socket Head Cap Screw M6*60	2
105	A Zone Down Overlay	1	180	Socket Head Cap Screw M6*20	20
108	Console Pcb	1	181	Locknut M3	2
109	Key Board	1	182	Locknut M8	12
110	Joint 1	1	183	Washer $\Phi 11 * \Phi 23 * 2$	6
111	Joint 2	1	184	Hexagon Socket Countersunk Head Cap Head Screw M8*35	6
112	Joint 3	1	185	Circlip For Shaft	2
113	12V Power Wire	1	186	Washer	4
114	Switch Pcb	1	187	Socket Head Cap Screw M8*15	2
115	Fan	1	188	Socket Head Cap Screw M8*30	10
116	Pulse Plate	1	189	Socket Head Cap Screw M8*80	2
117	Linked Wire Fron Pulse Pcb To Pcb	1	190	Hex Head Bolt M10*165	2
118	Pulse Connect Wire	1	191	Hex Head Bolt M10*180	2
119	Receptor	1	193	Power Wire Fixing Plate	1
120	Spd And Incl Harness	1	194	Band Cable	10
122	Emergency Switch	2	195	Double Wrench	1
123	Emergency Switch Wire	2	196	Lug Wrench	1
124	Console Wire Up	1	197	Hexagonal Socket Wrench	1
125	Ferrite	3	198	Double Wrench	1
126	Ferrite	2	199	Lug Wrench	1
150	Adjust Bumper	2	200	Hexagonal Socket Wrench	1
151	Bumper A	4	201	Tape	3.8
152	Bumper B	4	204	Phillip Screw St4.2*16	4
153	Bumper	4	205	Wheel	2
154	Insulation Bumper	1	206	Locknut M10	4
156	V-Belt	1	207	Locknut M12	2
158	Neck Bush	4	208	Washer $\Phi 9 * \Phi 22 * 2$	10
159	Clip Nut M6	6	209	Circuit Break Switch	2
160	Insulation Spacer	4	210	Earth Wire	1
161	Carriage Bolt M8*40	1	211	Motor	1
162	Countersunk Head Hexagon Riveted Nuts M5	12	212	Transducer	1
163	Countersunk Head Hexagon Riveted Nuts M6	2	213	Main Switch	4
164	Flat Head Hexagon Riveted Nuts M6	18	214	Connect Wire	1
165	Flat Head Hexagon Riveted Nuts M8	6	215	Console Wire Down	2
166	Hex Flange Nut M8	9	216	Connect Wire	2
167	Hex Flange Nut M16	2	221	Protective Sleeve	1
168	Hex Head Bolt M8*150	6	224	Actuator	1
169	Hex Head Bolt M10*25	4	225	Power Outlet	1
170	Hex Head Bolt M10*50	1	226	Power Wire	1
171	Hex Head Bolt M10*130	1	227	Ferrite	1
172	Phillip Screw M3*10	2	228	Ferrite	2
174	Phillip Screw M4*10	2	260	Ground Bumper	1
175	Phillip Screw M4*8	5	261	Serrated Lock Washers $\Phi 10$	4
176	Phillip Screw St4.2*13	18	262	Serrated Lock Washers $\Phi 8$	4
177	Phillip Screw M5*20	14			

Parts list220V

Item No.	Description	QTY	Item No.	Description	QTY
1	Console Frame	1	53	Earphone Hole Plug	1
2	Left Upright	1	54	A-Zone Up Cover	1
3	Right Upright	1	55	A-Zone Down Cover	1
4	Deck Frame	1	56	Emergency Switch Key	1
5	Elevating Frame	1	57	Fan Key	7
6	Left Handle Frame	1	58	Cool Down/Pause Key	1
7	Right Handle Frame	1	59	Limit Key Fixing Plate	1
8	Console Plate Frame	1	60	Emergency Switch Baffle	1
9	Motor Fixing Plate	1	61	Air Grid	1
10	Dust Proof Plate	1	62	Air Up Cover	1
11	Front Motor Cover Fixing L Plate	2	63	A-Zone Insert	1
12	Motor Cover Fixing L Plate	2	64	Console Back Cover	1
13	Elevate Rotational Sleeve	2	66	Start Key	1
14	Front Cover Fixing Plate	2	67	Console Bottom Plate	1
15	Console Linked Plate	1	68	Switch Fixing Plate	1
16	Middle Z Fixing Plate	1	69	Pulse Fixing Plate	2
17	Running Belt	1	70	Pulse Sheet	4
18	Controller U Fixing Plate	1	71	Nylon Shaft	1
19	Elevating Frame Fixing Shoulder Bolt	2	72	Left Side	1
20	Motor Cover	1	73	Right Side	1
21	Left Front Decorative Cover	1	74	Left Steel Side	1
22	Right Front Decorative Cover	1	75	Right Steel Side	1
24	Running Board	1	76	Reposition Rack	1
25	Left Rear Adjusting Seat	1	77	Restrict Spring	1
26	Right Rear Adjusting Seat	1	80	Console Component	1
27	Left Rear Decorative Cover	1	81	Flat Head Hexagon Riveted Nuts M8	4
28	Right Rear Decorative Cover	1	82	Countersunk Head Hexagon Riveted Nuts M5	18
29	Middle Protective Cover	1	83	Phillip Screw M4*40	2
30	Switch Cover	1	84	Phillip Screw M5*15	39
32	Front Roller	1	85	Phillip Screw M5*20	4
33	Rear Roller	1	86	Phillip Screw M5*35	6
35	Left Handle	1	87	Phillip Screw St2.9*6.5	17
36	Right Handle	1	88	Phillip Screw St2.9*9.5	4
37	Console Left Up Cover	1	89	Phillip Screw St4.2*13	9
38	Console Right Up Cover	1	90	Phillip Screw St4.2*50	4
39	Console Left Down Cover	1	91	Hex Head Bolt M6*15	4
40	Console Right Down Cover	1	92	Socket Head Cap Screw M8*15	4
41	Fan Fixing Plate	1	93	Socket Head Cap Screw M8*20	8
43	Left Routing Cover	1	94	Socket Head Cap Screw M8*55	2
44	Right Routing Cover	1	95	Hex Nut M4	2
45	Left Bolt Cover	1	96	Locknut M8	2
46	Right Bolt Cover	1	97	Washer $\Phi 9 \times \Phi 22 \times 2$	14
47	Cup Holder	1	98	Split Damping Ring $\Phi 9$	1
48	Left Signing Light Fixing Plate	1	99	Clip Nut	4
49	Right Signing Light Fixing Plate	1	100	Safe Key Clamp	1
52	Console Signing Light Cover	2	101	Console Overlay	1

Parts list220V

Item No.	Description	QTY	Item No.	Description	QTY
102	Sign Paster	1	179	Socket Head Cap Screw M6*60	2
104	A Zone Up Overlay	1	180	Socket Head Cap Screw M6*20	20
105	A Zone Down Overlay	1	181	Locknut M3	2
108	Console Pcb	1	182	Locknut M8	12
109	Key Board	1	183	Washer $\Phi 11 * \Phi 23 * 2$	6
110	Joint 1	1	184	Hexagon Socket Countersunk Head Cap Head Screw M8*35	6
111	Joint 2	1	185	Circlip For Shaft	2
112	Joint 3	1	186	Washer	4
113	12V Power Wire	1	187	Socket Head Cap Screw M8*15	2
114	Switch Pcb	1	188	Socket Head Cap Screw M8*30	10
115	Fan	1	189	Socket Head Cap Screw M8*80	2
116	Pulse Plate	1	190	Hex Head Bolt M10*165	2
117	Linked Wire Fron Pulse Pcb To Pcb	1	191	Hex Head Bolt M10*180	2
118	Pulse Connect Wire	1	193	Power Wire Fixing Plate	1
119	Receptor	1	194	Band Cable	10
120	Spd And Incl Harness	1	195	Double Wrench	1
122	Emergency Switch	2	196	Lug Wrench	1
123	Emergency Switch Wire	2	197	Hexagonal Socket Wrench	1
124	Console Wire Up	1	198	Double Wrench	1
125	Ferrite	3	199	Lug Wrench	1
126	Ferrite	2	200	Hexagonal Socket Wrench	1
150	Adjust Bumper	2	201	Tape	3.8
151	Bumper A	4	204	Phillip Screw St4.2*16	4
152	Bumper B	4	205	Wheel	2
153	Bumper	4	206	Locknut M10	4
154	Insulation Bumper	1	207	Locknut M12	2
156	V-Belt	1	208	Washer $\Phi 9 * \Phi 22 * 2$	10
158	Neck Bush	4	209	Circuit Break Switch	2
159	Clip Nut M6	6	210	Earth Wire	1
160	Insulation Spacer	4	211	Motor	1
161	Carriage Bolt M8*40	1	212	Transducer	1
162	Countersunk Head Hexagon Riveted Nuts M5	12	213	Main Switch	4
163	Countersunk Head Hexagon Riveted Nuts M6	2	214	Connect Wire	1
164	Flat Head Hexagon Riveted Nuts M6	18	215	Console Wire Down	2
165	Flat Head Hexagon Riveted Nuts M8	6	216	Connect Wire	2
166	Hex Flange Nut M8	9	221	Protective Sleeve	1
167	Hex Flange Nut M16	2	222	Inductance	1
168	Hex Head Bolt M8*150	6	223	Filter	1
169	Hex Head Bolt M10*25	4	224	Actuator	1
170	Hex Head Bolt M10*50	1	225	Power Outlet	1
171	Hex Head Bolt M10*130	1	226	Power Wire	1
172	Phillip Screw M3*10	2	227	Ferrite	1
174	Phillip Screw M4*10	2	228	Ferrite	2
175	Phillip Screw M4*8	5	260	Ground Bumper	1
176	Phillip Screw St4.2*13	18	261	Serrated Lock Washers $\Phi 10$	4
177	Phillip Screw M5*20	14	262	Serrated Lock Washers $\Phi 8$	4
178	Phillip Screw M6*30	6			

Application Precautions

IMPORTANT SAFETY INSTRUCTIONS

When using an electrical appliance, basic precautions should always be followed, including the following:

Read all instructions before using this Treadmill:

DANGER - To reduce the risk of electric shock:

1. Always unplug this appliance from the electrical outlet immediately after using and before cleaning.
2. Do not reach for a plug that has fallen into water. Unplug immediately.
3. Do not use while bathing or in a shower.
4. Do not place or store the treadmill where it can fall or be pulled into a tub or sink. Do not place in or drop into water or other liquid.

WARNING - To reduce the risk of burns, fire, electric shock, or injury to persons:

1. An appliance should never be left unattended when plugged in. Unplug from outlet when not in use, and before putting on or taking off parts.
2. Do not operate under blanket or pillow. Excessive heating can occur and cause fire, electric shock, or injury to users.
3. Close supervision is necessary when this treadmill is used by, on, or near children, invalids, or disabled persons. Keep children away from extended back, foot support (or other similar parts).
4. Use this treadmill only for its intended use as described in this manual. Do not use attachments not recommended by the manufacturer.
5. Never operate this treadmill if it has a damaged cord or plug, if it is not working properly, if it has been dropped or damaged, or dropped into water. Return the Treadmill to a service center for examination and repair.
6. Do not carry this treadmill by supply cord or use cord as a handle.
7. Keep the cord away from heated surfaces.
8. Never operate the treadmill with the air openings blocked. Keep the air openings free of lint, hair, and the like. Never operate on a soft surface such as a bed or couch where the air openings may be blocked.

Application Precautions

9. Never drop or insert any object into any opening.
10. Do not use outdoors.
11. Do not operate where aerosol (spray) products are being used or where oxygen is being administered.
12. To disconnect, turn all controls to the off position, then remove plug from outlet.
13. Connect this Treadmill to a properly grounded outlet only. See Grounding Instructions.
14. The equipment is designed for commercial use, Maximum load is 180KG.

SAVE THESE INSTRUCTIONS

GROUNDING INSTRUCTION

This product must be grounded. If it should malfunction or breakdown, grounding provides a path of least resistance for electric current to reduce the risk of electric shock. This product is equipped with a cord having an equipment-grounding conductor and a grounding plug. The plug must be plugged into an appropriate outlet that is properly installed and grounded in accordance with all local codes and ordinances.

DANGER - Improper connection of the equipment-grounding conductor can result in a risk of electric shock. Check with a qualified electrician or service technician if you are in doubt as to whether the product is properly grounded. Do not modify the plug provided with the product - if it will not fit the outlet, have a proper outlet installed by a qualified electrician.

This product is rated more than 15 amperes and is for use on a circuit having a nominal rating of 120 volts and is factory-equipped with a specific electric cord and plug to permit connection to a proper electric circuit. Make sure that the product is connected to an outlet having the same configuration as the plug. No adapter should be used with this product. If the product must be reconnected for use on a different type of electric circuit, the reconnection should be made by qualified service personnel.

Application Precautions

CAUTION - Risk of Injury to Persons - To Avoid Injury, use extreme caution when stepping onto or off of a moving belt. Read Instruction Manual Before Using.

ATTENTION - Risque des blessures aux personnes - Pour éviter des blessures, avec une extrême prudence en marchant sur ou hors d'une ceinture mobile. Lisez le manuel d'instruction avant utilisation.

CAUTION - To Reduce The Risk Of Injury From Moving Parts - Unplug Before Servicing.

ATTENTION - Pour réduire le risque de blessures des pièces mobiles - Débranchez avant l'entretien.

WARNING - To Reduce the Risk of Electric Shock - Unplug Before Cleaning or Servicing.

AVERTISSEMENT - Pour réduire le risque du choc électrique - Débranchez avant le nettoyage ou l'entretien.

Application Precautions

Remember to take the time to review owner's manuals before you start.

1. Before using this treadmill or starting any exercise program, consult your physician and accompanied by specialized person. Adjust the speed not over 8KMH.
2. Take the time to perform the stretching exercise provided to avoid injury.
3. If you have heart problems, and/ or the other diseases, do not use the treadmill programs without receiving approval from your physician.
4. Stop exercising or call physician if you feel uncomfortable.
5. Do not leave children unsupervised and disabled person near or on the treadmill. Should be accompanied by supervisors.
6. Running is oxygen exercise, recommended 30 minutes per time is reasonable.
7. Wear comfortable, good-quality walking or running shoes and appropriate clothing. Do not wear fibre clothing to avoid electrical shock and damage the treadmill.
8. Do not use the treadmill with bare feet, sandals, socks or stockings to avoid any risk of injuries. Wear comfortable shoes or cotton socks.
9. Failure to follow these instructions will void the treadmill warranty.
10. If the supply cord is damaged, it must be replaced by the manufacturer or its service agent or a similarly qualified person in order to avoid a hazard.

Application

Warming-up exercise

EXERCISE GUIDELINES

WARNING! Before beginning this or any exercise program, you should consult your physician. This is especially important for individuals over the age of 35 or individuals with pre-existing health problems.

Warming up prepares the body for the exercise by increasing circulation, supplying more oxygen to the muscles and raising body temperature. Begin each workout with 5 to 10 minutes of stretching and light exercise to warm up. The photos on this page show several forms of basic stretching you may perform before your workouts. In order to achieve an adequate warm-up, perform each stretch three times.

TOE TOUCH STRETCH

Stand, bending your knees slightly and slowly bend forward from your hips. Allow your back and shoulders to relax as you reach down toward your toes as far as possible. Hold for 15 counts, then relax. This will stretch your hamstrings, back of knees, and back.

HAMSTRING STRETCH

Sit with one leg extended. Bring the sole of the opposite foot toward you and rest it against the inner thigh of your extended leg. Reach toward your toes as far as possible. Hold for 15 counts, then relax. This will stretch your hamstrings, lower back, and groin.

CALF/ACHILLES STRETCH

With one leg in front of the other, reach forward and place your hands against a wall. Keep your back leg straight and your back foot flat on the floor. Bend your front leg, lean forward and move your hips toward the wall. Hold for 15 counts, then relax. To cause further stretching of the Achilles tendon, bend your back leg as well. This will stretch your calves, Achilles tendons, and ankles.

QUADRICEPS STRETCH

With one hand against a wall for balance, reach back and grasp one foot with your other hand. Bring your heel as close to your buttocks as possible. Hold for 15 counts, then relax. This will stretch your quadriceps and hip muscles.

INNER THIGH STRETCH

Sit with the soles of your feet together and your knees outward. Pull your feet toward your groin area as far as possible. Hold for 15 counts, then relax. This will stretch your quadriceps and hip muscles.

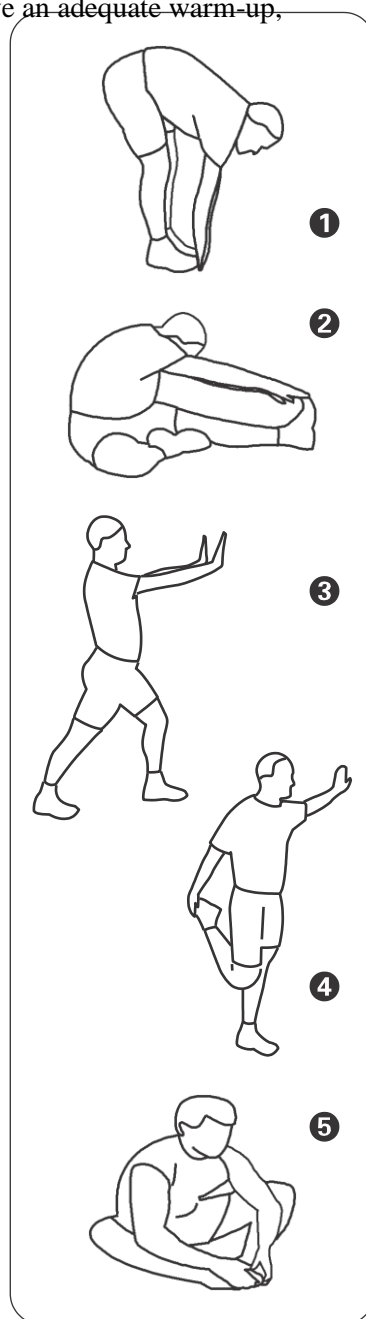

Application

Console parameter specification

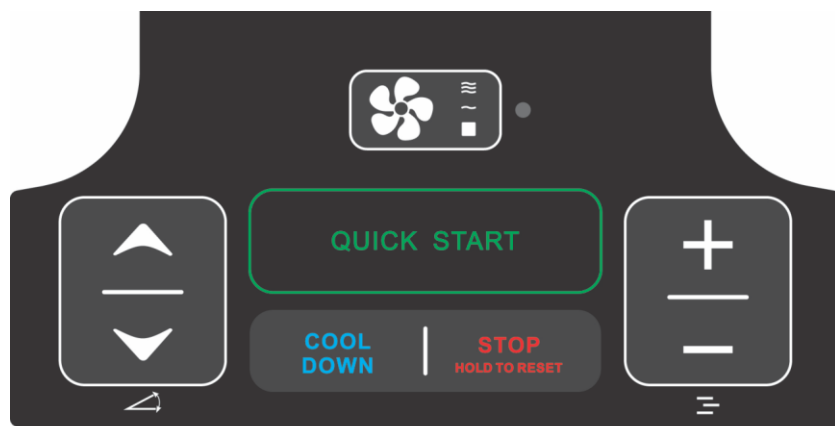
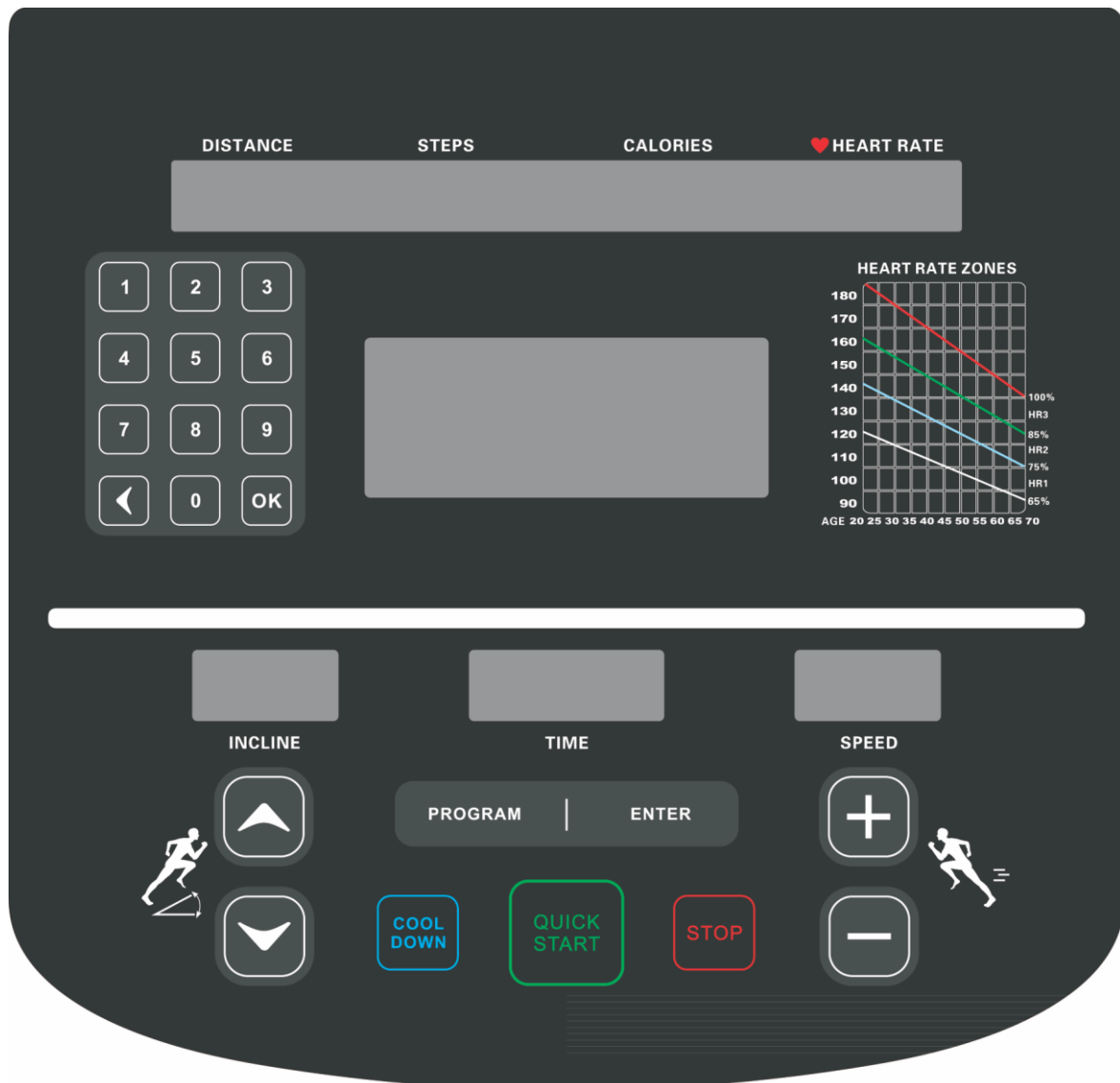

Console parameter specification

110V

INPUT VOLTAGE:	110-120V~ 50/60Hz
RATED CURRENT:	18A
SPEED RANGE:	1.0-20KPH
INCLINE RANGE:	0-15%
DISPLAY:	SPEED, TIME, INCLINE, DISTANCE, STEPS, CALORIE, HEART RATE, DOT MATRIX

220V

INPUT VOLTAGE:	220-240V~ 50/60Hz
RATED POWER:	2200W
SPEED RANGE:	1.0-20KPH
INCLINE RANGE:	0-15%
DISPLAY:	SPEED, TIME, INCLINE, DISTANCE, STEPS, CALORIE, HEART RATE, DOT MATRIX

CONSOLE PANEL FUNCTION

1. TIME WINDOW

Indicates elapsed time after pressing start in minutes and seconds (0-99minutes, 0-59seconds).

2. SPEED WINDOW

Indicates workouts speed MPH(miles per hour) or KPH (kilometer per hour) in 0.1 increments.

3. INCLINE WINDOW

Indicates incline in percent of grade 0—15% in 1 increments.

4. PULSE WINDOW

Indicates user's current heart rate (BPM).

5. CALORIES WINDOW

Indicates estimated calories used based on 68Kg person at the indicated speed, incline, and time.

6. DISTANCE WINDOW

Indicates Kilometers or Miles traveled in 0.01 increments up to 9.99 and 0.1 increments starting at 10.0 (Range 0.01---999).

7 STEPS WINDOW

Indicates user exercise steps.

Console parameter specification

8. Dot MATRIX

8.1 Indicates the lap count and displays which lap you are on. (One lap is 400 meters)

8.2 Indicates 'PRESS QUICK STARTOR SELECTPROGRAM' when turn on power.

8.3 Indicates message when enter value.

8.4 Indicates workout curve in Program mode.

CONSOLE BUTTONS

1. START

This button is used to start the current program.

2. STOP

This button is used to stop the current program.

3. SPEED+ and SPEED-

This button is used to adjust the speed of the treadmill during workout.

4. INCLINE+ and INCLINE-

These buttons are used to adjust the incline of the treadmill during workout.

5. NUMERIC KEYPAD

These buttons are used to cycle through to the desired data.

6. OK

This button is used to enter value of program mode.

7. PROGRAM

These buttons are used to cycle through to the desired program.

8. ENTER

This button is used to enter value of program mode.

9. COOL DOWN

This button is used select workout "cool down mode".

10. DELETE (▲) BUTTON

This button is used delete data.

11. FANBUTTON

Turn on and turn off the fan and adjust the fan speed.

Console parameter specification

CONSOLE OPERATION

1. QUICK START/MANUAL MODE

1.1 Plug into surge protector outlet. Stand on the treadmill and straddle belt.

1.2 Turn on power.

1.3 The LED screen scrolls "PRESS QUICK START OR SELECT PROGRAM".

1.3.1 If press start button through manual mode;

1.3.2 If press PROGRAM Button, will cycle through to the desired CARDIO MODE, FATBURN MODE, STEP MODE, 5KM MODE, 10KM MODE, HILL MODE, HR=65% MODE, HR=75% MODE, HR=85% MODE, CALORIES COUNT DOWN, TIME COUNT DOWN, DISTANCE COUNT DOWN.

1.4 Press STOP button belt will stop, speed window will be zero, other window will be keep. Press STOP button again, reset total window.

2. PROGRAM MODE

When console turns on, the LED screen scrolls "PRESS QUICK START OR SELECT PROGRAM". If press PROGRAM Button, will cycle through to the desired CARDIO MODE, FATBURN MODE, STEP MODE, 5KM MODE, 10KM MODE, HILL MODE, HR=65% MODE, HR=75% MODE, HR=85% MODE. CALORIES COUNT DOWN\ TIME COUNT DOWN\ DISTANCE COUNT DOWN.

2.1 If CARDIO MODE is selected

2.1.1 Dot matrix scrolls 'CARDIO MODE ENTER TIME';

2.1.2 Time window will be flash '30:00', Use speed + or – button to adjust default value;

2.1.3 Press ENTER to confirm;

2.1.4 Dot matrix scrolls 'ENTER WEIGHT', Time window will be flash '68', Use speed + or – button to adjust default value;

2.1.5 Press ENTER to confirm;

2.1.6 Dot matrix scrolls 'PRESS QUICK START';

2.1.7 If press QUICK START Button, Top time LED updates;

2.1.8 LED displays "3", "2", "1", Belt starts moving.

Console parameter specification

2.2 If FATBURN MODE is selected

2.2.1 Dot matrix scrolls 'FATBURN MODE ENTERTIME';

2.2.2 Time window will be flash '30:00', Use speed + or – button to adjust default value;

2.2.3 Press ENTER to confirm;

2.2.4 Dot matrix scrolls 'ENTER WEIGHT', Time window will be flash '68', Use speed + or – button to adjust default value;

2.2.5 Press ENTER to confirm;

2.2.6 Dot matrix scrolls 'PRESS QUICK START';

2.2.7 If press QUICK START Button, Top time LED updates;

2.2.8 LED displays "3", "2", "1", Belt starts moving.

2.3 If STEP MODE is selected

2.3.1 Dot matrix scrolls 'STEP MODE ENTERSTEPS';

2.3.2 Step window will be flash '8000', Use speed + or – button to adjust default value;

2.3.3 Press ENTER to confirm;

2.3.4 Dot matrix scrolls 'ENTER WEIGHT', Time window will be flash '68', Use speed + or – button to adjust default value;

2.3.5 Press ENTER to confirm;

2.3.6 Dot matrix scrolls 'PRESS QUICK START';

2.3.7 If press QUICK START Button, Top time LED updates;

2.3.8 LED displays "3", "2", "1", Belt starts moving.

2.4 If 5KM MODE is selected

2.4.1 Dot matrix scrolls '5KM MODE';

2.4.2 Press ENTER to confirm;

2.4.3 Dot matrix scrolls 'ENTER WEIGHT', Time window will be flash '68', Use speed + or – button to adjust default value;

2.4.4 Press ENTER to confirm;

2.4.5 Dot matrix scrolls 'PRESS QUICK START';

2.4.6 If press QUICK START Button, Top time LED updates;

2.4.7 LED displays "3", "2", "1", Belt starts moving.

Console parameter specification

2.5 If 10KM MODE is selected

- 2.5.1 Dot matrix scrolls '10KM MODE';
- 2.5.2 Press ENTER to confirm;
- 2.5.3 Dot matrix scrolls 'ENTER WEIGHT', Time window will be flash '68', Use speed + or – button to adjust default value;
- 2.5.4 Press ENTER to confirm;
- 2.5.5 Dot matrix scrolls 'PRESS QUICK START';
- 2.5.6 If press QUICK START Button, Top time LED updates;
- 2.5.7 LED displays "3", "2", "1", Belt starts moving.

2.6 If HILL MODE is selected

- 2.6.1 Dot matrix scrolls 'HILL MODE ENTER TIME';
- 2.6.2 Time window will be flash '30:00', Use speed + or – button to adjust default value;
- 2.6.3 Press ENTER to confirm;
- 2.6.4 Dot matrix scrolls 'ENTER WEIGHT', Time window will be flash '68', Use speed + or – button to adjust default value;
- 2.6.5 Press ENTER to confirm;
- 2.6.6 Dot matrix scrolls 'PRESS QUICK START';
- 2.6.7 If press QUICK START Button, Top time LED updates;
- 2.6.8 LED displays "3", "2", "1", Belt starts moving.

2.7 If HR=65% MODE is selected

- 2.7.1 Dot matrix scrolls 'HR=65% MODE ENTER TIME';
- 2.7.2 Time window will be flash '30:00', Use speed + or – button to adjust default value;
- 2.7.3 Press ENTER to confirm;
- 2.7.4 Dot matrix scrolls 'ENTER WEIGHT', Time window will be flash '68', Use speed + or – button to adjust default value;
- 2.7.5 Press ENTER to confirm;
- 2.7.6 Dot matrix scrolls 'ENTER AGE', Calories window will be flash '25', Use speed + or – button to adjust default value;
- 2.7.7 Press ENTER to confirm;
- 2.7.8 Dot matrix scrolls 'PRESS QUICK START';

Console parameter specification

2.7.9 If press QUICK START Button, Top time LED updates;

2.7.10 LED displays "3", "2", "1", Belt starts moving.

2.8 If HR=75% MODE is selected

2.8.1 Dot matrix scrolls 'HR=75% MODE ENTER TIME';

2.8.2 Same as above.

2.9 If HR=85% MODE is selected

2.9.1 Dot matrix scrolls 'HR=85% MODE ENTER TIME';

2.9.2 Same as above.

2.10 If CALORIES COUNT DOWN is selected

2.10.1 Dot matrix scrolls 'CALORIES COUNT DOWN'.

2.10.2 Calories window will be flash '20.0', Use speed + or – button to adjust default value;

2.10.3 Press ENTER to confirm;

2.10.4 Dot matrix scrolls 'ENTER WEIGHT', Time window will be flash '68', Use speed + or – button to adjust default value;

2.10.5 Press ENTER to confirm;

2.10.6 Dot matrix scrolls 'PRESS QUICK START';

2.10.7 If press QUICK START Button, Top time LED updates;

2.10.8 LED displays "3", "2", "1", Belt starts moving.

2.11 If TIME COUNT DOWN is selected

2.11.1 Dot matrix scrolls 'TIME COUNT DOWN';

2.11.2 Time window will be flash '30:00', Use speed + or – button to adjust default value;

2.11.3 Press ENTER to confirm;

2.11.4 Dot matrix scrolls 'ENTER WEIGHT', Time window will be flash '68', Use speed + or – button to adjust default value;

2.11.5 Press ENTER to confirm;

2.11.6 Dot matrix scrolls 'PRESS QUICK START';

2.11.7 If press QUICK START Button, Top time LED updates;

2.11.8 LED displays "3", "2", "1", Belt starts moving.

Console parameter specification

2.12 If DISTANCE COUNT DOWN is selected

2.12.1 Dot matrix scrolls 'CARDIO MODE ENTERTIME';

2.12.2 Distance window will be flash '3.00', Use speed + or – button to adjust default value;

2.12.3 Press ENTER to confirm;

2.12.4 Dot matrix scrolls 'ENTER WEIGHT', Time window will be flash '68', Use speed + or – button to adjust default value;

2.12.5 Press ENTER to confirm;

2.12.6 Dot matrix scrolls 'PRESS QUICK START';

2.12.7 If press QUICK START Button, Top time LED updates;

2.12.8 LED displays "3", "2", "1", Belt starts moving.

3. TREADMILL ERROR MESSAGES

3.1 Communication Error message: ER01

3.1.1 Check console and the main communication cable connection;

3.1.2 Check inverter and the main communication cable connection;

3.1.3 Replace inverter;

3.1.4 Replace console.

3.2 Elevation Error messages: ER02

3.2.1 Check power cable of actuator and inverter connection;

3.2.2 Check cable of sensor of actuator and inverter connection;

3.2.3 Replace actuator;

3.2.4 Replace inverter.

3.3 Safe-key Error message: ER03

3.3.1 Check safe-key button;

3.3.2 Check cable of safe-key;

3.3.3 Replace safe-key PCB;

3.3.4 Replace console.

Console parameter specification

3.4 Over current message: ER04

- 3.4.1 Add silicon to run belt and board;
- 3.4.2 Replace inverter;
- 3.4.3 Replace motor.

3.5 Lower voltage message: ER05

- 3.5.1 Check power AC200-240V (105-125V).

3.6 Over load message: ER06

- 3.6.1 Add silicon to run belt and board;
- 3.6.2 Replace run belt and board;
- 3.6.3 Replace inverter;
- 3.6.4 Replace motor.

3.7 Emergency stop message: ER07

- 3.7.1 Reset Emergency switch then press STOP button;
- 3.7.2 Check cable of Emergency switch and Emergency switch connection;
- 3.7.3 Replace Emergency switch;
- 3.7.4 Replace inverter.

3.8 The console no power

- 3.8.1 Check the AC power;
- 3.8.2 Turn on the power switch;
- 3.8.3 Check the communication cable and console connection;
- 3.8.4 Check the communication cable and inverter connection;
- 3.8.5 Replace the communication cable;
- 3.8.6 Replace the power cable.

Parameter settings

Inch/ metric interchange

After inch/metric interchange, the initial velocity will be increased at the startup.

Hold down the "Start" button, then press the "safety switch" and release, enter the inch/metric interchange mode. Press the "speed +" button or "speed -" button to select the desired speed.

If the speed window shows "S1", it is metric units: If the speed window displays "ENG", it's Imperial units, select the desired metric or imperial units, then press OK button to confirm and save, as shown in the picture:

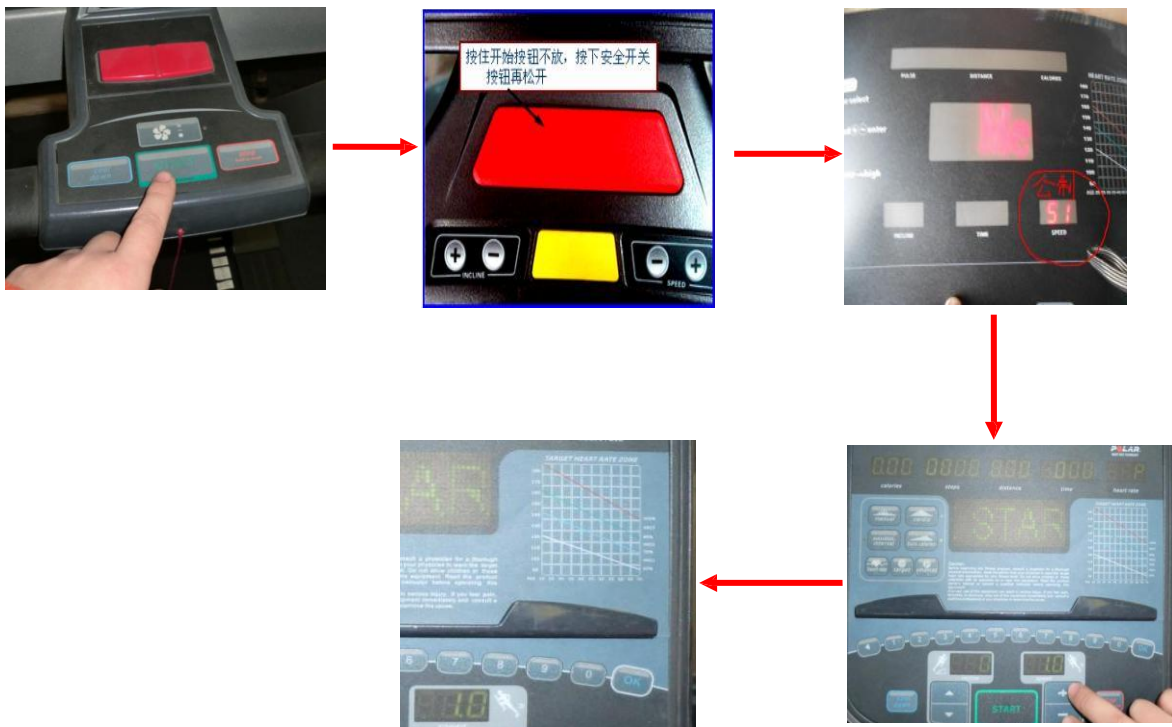

Parameter settings

System automatic calibration

Treadmill automatic calibration method

When replacing console or inverter or incline motor, press down both the INCLINE [+ , -] and SPEED [+ , -] buttons at the same time for 3 seconds to enter the setting state, the console shows the time [2:30 TIME], press the STOP button after setting, it is completed automatically

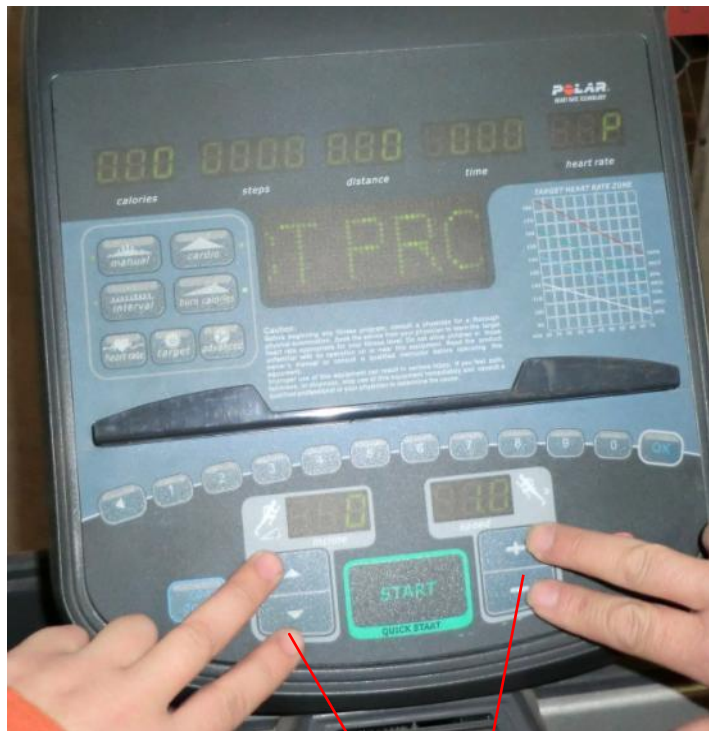

Press down at the same time

Maintenance

Main electrical connection diagram 110V

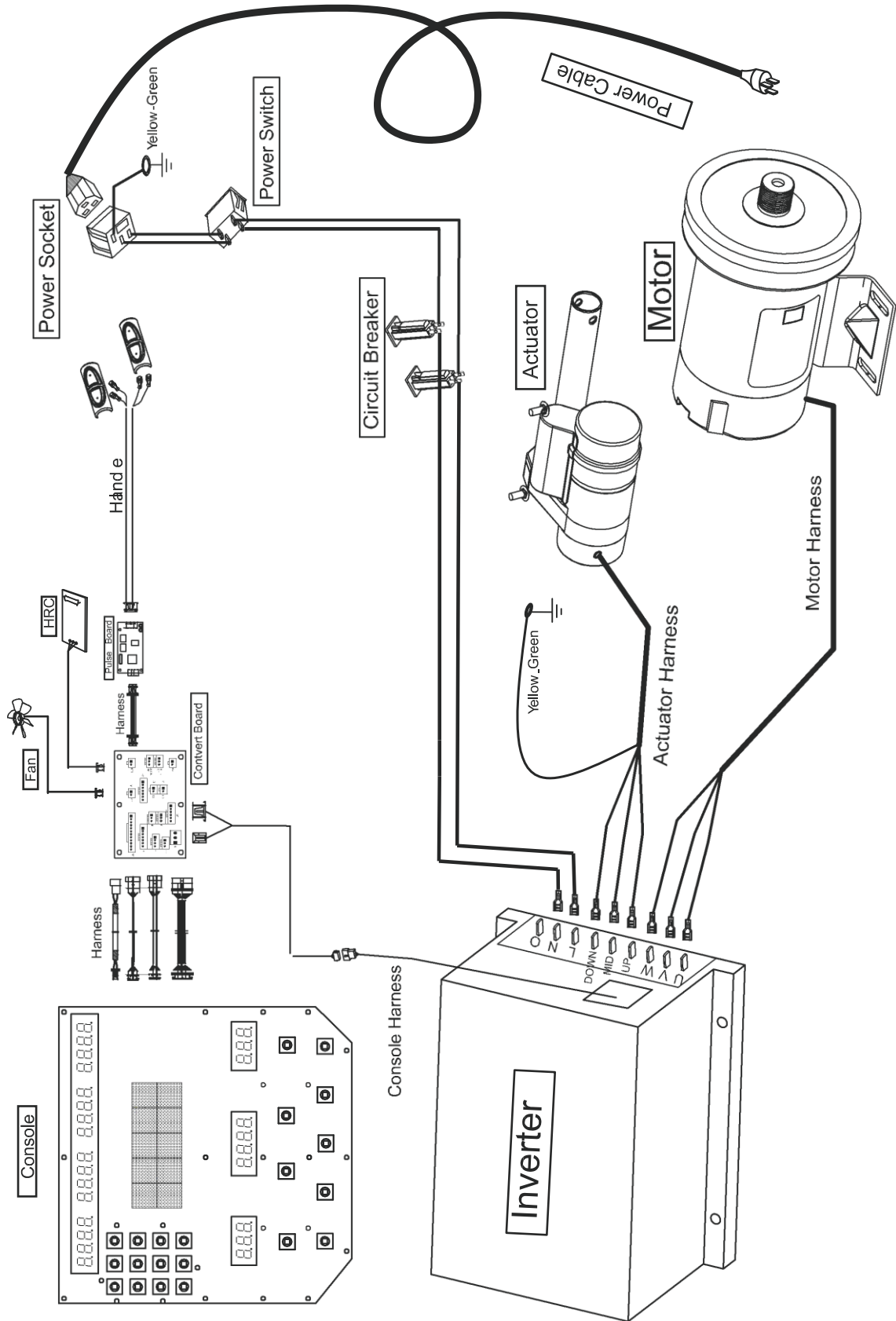

Main electrical connection diagram 220V

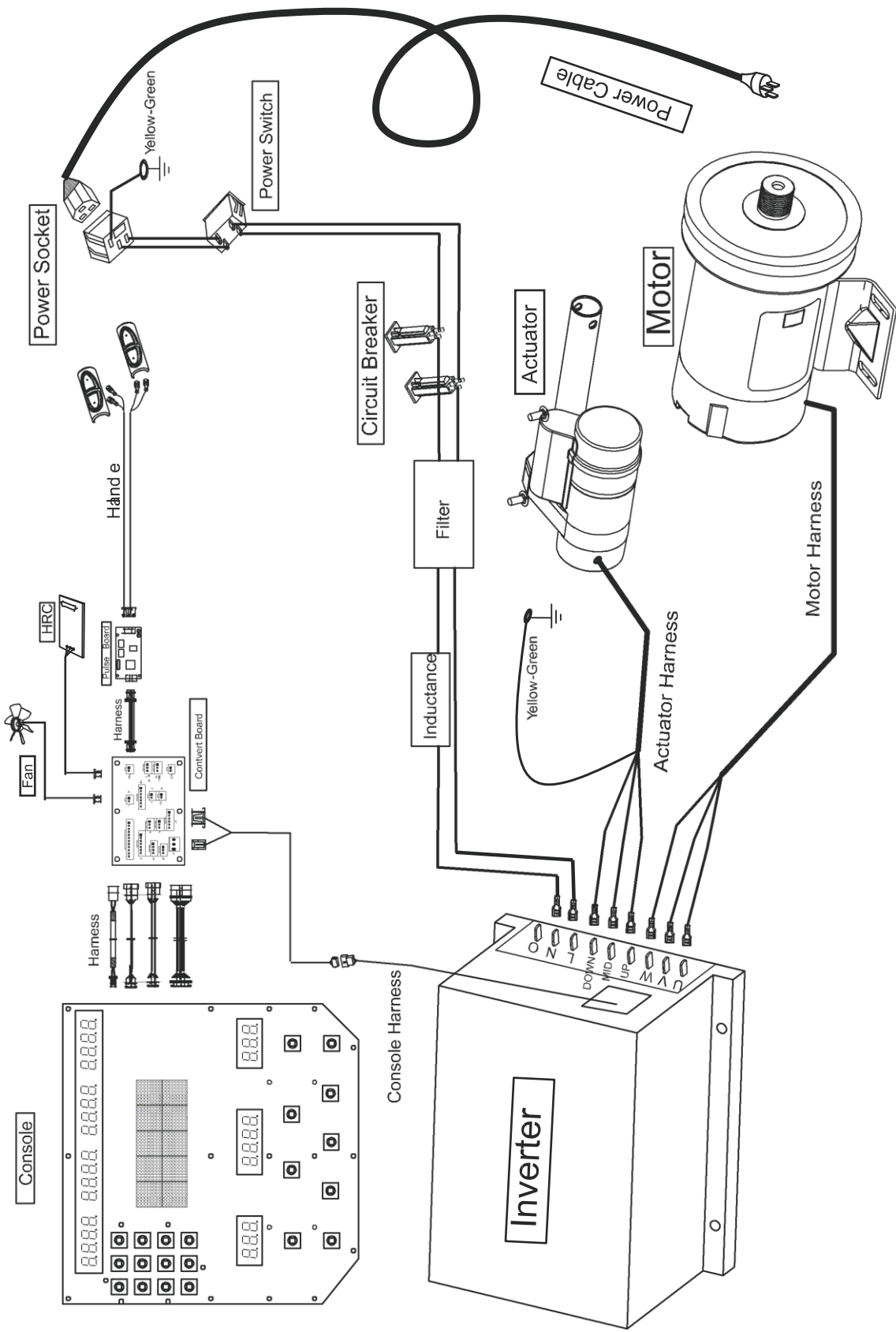

Maintenance Maintenance tools



Slotted and cross screwdriver



Adjustable wrench



Hammer



A set of socket wrench



Test pencil



Pliers



Multimeter



A set of socket head wrench



Socket wrench



Rubber gloves



Hair brush



Air-blowing



Butter



Rag



Alcohol

Maintenance

Fault and Maintenance Instructions

1. The treadmill does not start, and console displays ERO1 ----- communication failure

1.1. check console wire and the console for any loosening or coming off;

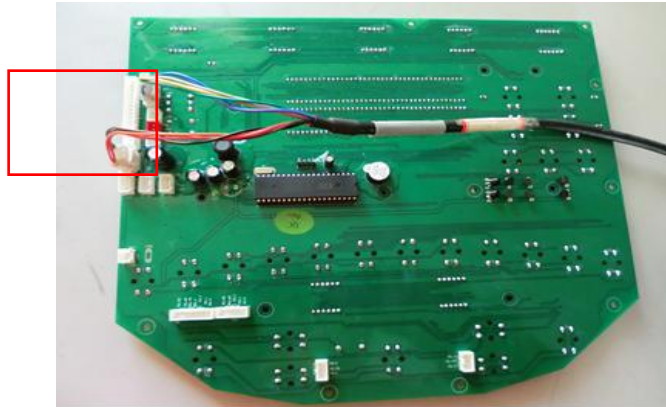

1.2 check for any loosening or falling off between console wire and the inverter;

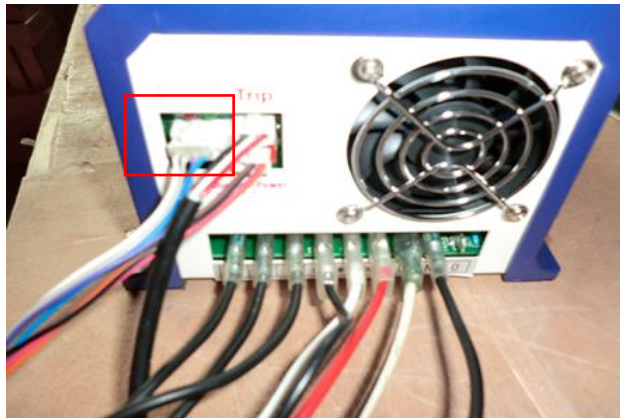

1.3 check whether the contact between the upper section or lower section of console wire and the intermediate adapter plate is good or squeezed;

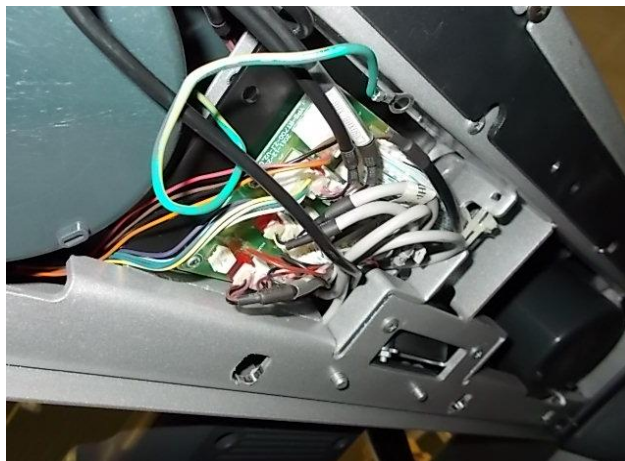

Maintenance

Fault and Maintenance Instructions

1.4 The inverter is damaged



1.5 The console is damaged

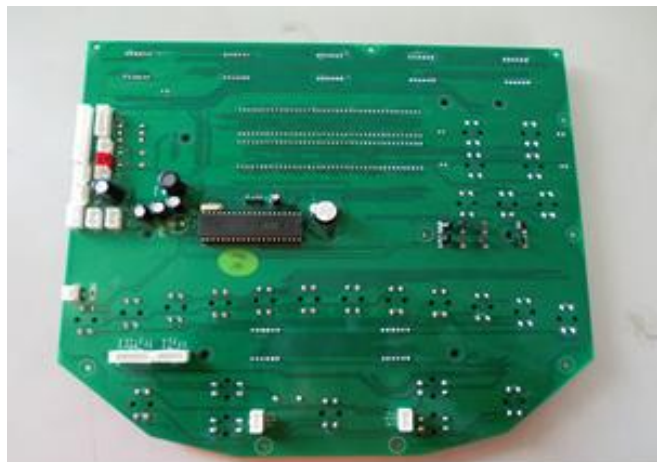

1.6 Check whether the ground wire of the treadmill is in good contact



Maintenance

Fault and Maintenance Instructions

2、 the treadmill can be started, the console displays ER02 ----incline motor system abnormalities

First auto correction of the angle, if not work, check as per the following steps:

2.1 check for any loosening or falling off between the power wire of the incline motor and the inverter; pay attention to the color of the wires

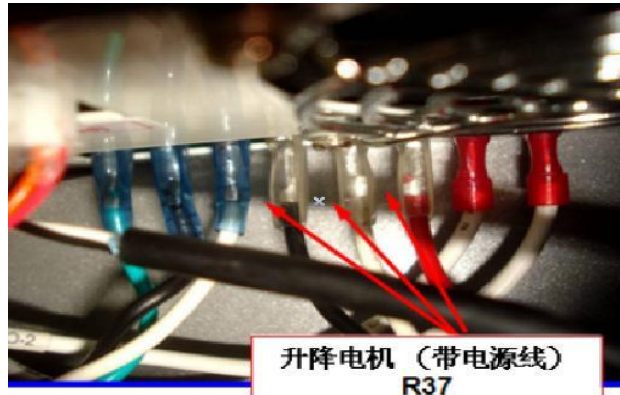

2.2 check for any loosening or falling off between signal wire of the incline motor and the inverter;



2.3 check whether the incline motor is damaged;



Maintenance

Fault and Maintenance Instructions

2.4 whether it is in good contact between the intermediate adapter plat or squeezed;



2.5 Check whether the inverter is damaged; inspection methods: press the stop button first to eliminate the fault code, and then continuously press the incline + button, if there is change in the number displayed on the angle window of the console, but the incline motor only moves a little or does not move, indicating that the inverter is damaged.



3.The treadmill does not start, and the console displays ER03----- safety switch abnormalities

3.1 check whether the safety switch is unhindered or moves freely;



Maintenance

Fault and Maintenance Instructions

3.2 check whether the plug of connecting wire to the safety switch is loose or fall off;

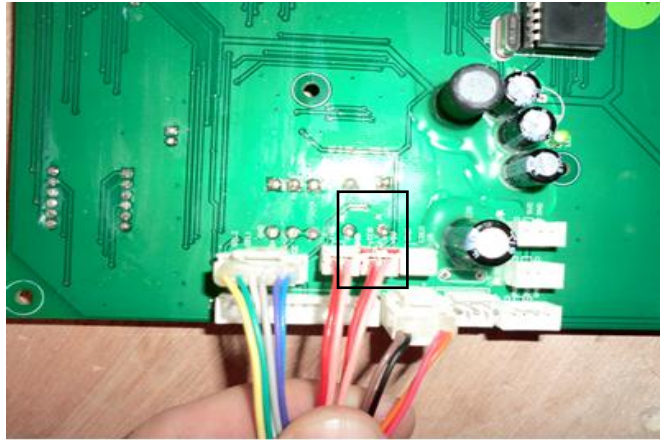

3.3 Check whether the safety switch is damaged; to test the short circuit emergency switch, press the start button to see whether it is normal, if normal, replacement of the micro switch can solve the problem.

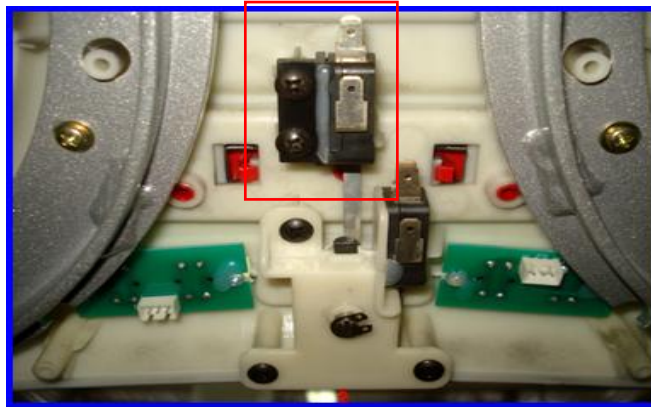

3.4 check whether the contact between intermediate adapter plate is good or squeezed;



Maintenance

Fault and Maintenance Instructions

3.5 If the above methods do not work, replace the console board

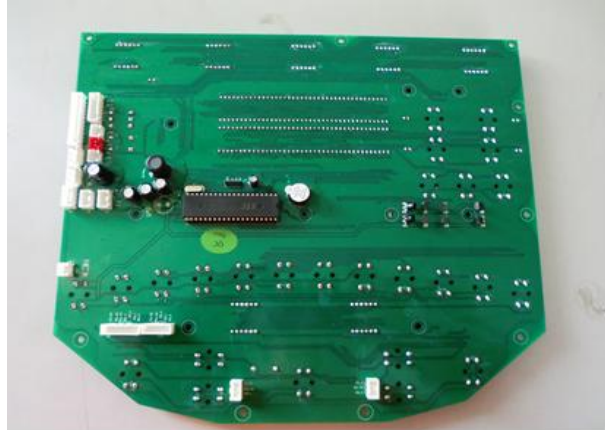

4. The treadmill does not start, console shows ER04 ----- overcurrent protection

4.1 Check whether the motor is damaged:

Normally it is mechanical failure, remove the v-ribbed belt, if the motor does not turn and the fault persists, indicating the motor is damaged. If the motor is running,

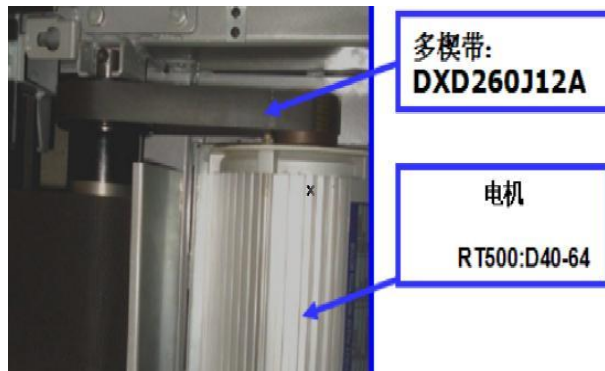

4.2 Check whether the inverter is damaged; first turn off the power switch on the machine, five minutes later, turn on the power switch again to start the treadmill, if the treadmill does not start, displaying ER04, the inverter is damaged, replace the inverter. If the treadmill can be started again normally, check the mechanical parts as per the solutions to fault ER06 code.



Maintenance

Fault and Maintenance Instructions

5 The treadmill does not start, and console shows ER05 ----- undervoltage protection

5.1. Please check whether the power supply voltage is at the normal value: AC 200-240V;

5.2. Check whether the power supply voltage has excessive fluctuation



6 The treadmill does not start, console shows ER06 ----- overload protection

6.1. If a fault occurs in use, it means the running belt is lack of lubrication, increasing the friction between the running board and running belt, resulting in an increase in the load;



6.2. The running board or running belt is badly worn



Maintenance

Fault and maintenance instructions

6.3 Check the motor wire for loosening or coming off;



6.4 Check the inverter for any damage;



6.5 Check whether the motor is damaged: Remove ribbed belt, if the motor does not turn and the fault persists, the motor is damaged. If the motor is running normally, it is mechanical failure

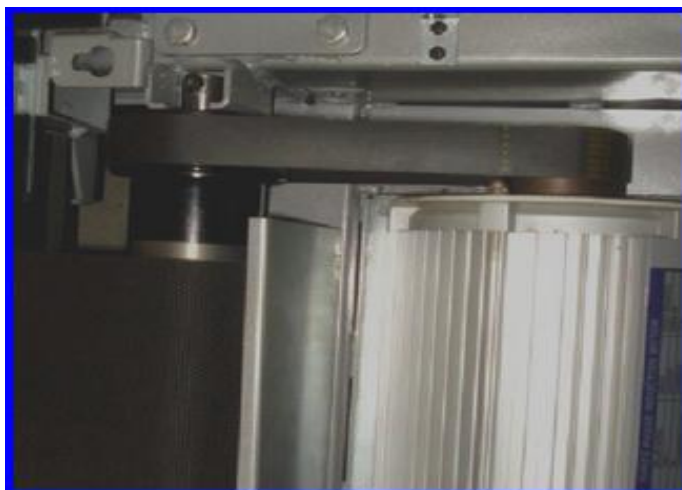

Maintenance

Fault and maintenance instructions

6.6 clean up the motor dust



6.7 check whether the motor is damaged:



7. The treadmill does not start, console shows ER07 ----- emergency protection

7.1 Check whether the CE emergency switch is in the locked state, if in a locked state, press down the yellow CE switch, and press the stop button to return the console back to normal state



Maintenance

Fault and maintenance instructions

7.2 It still displays ER07, check CE emergency switch: open the handle cover under the console, short circuit emergency switch, press the start button to see whether it is normal, if normal, replace the micro switch.



7.3 Check whether the CE safety switch wire plug is loose or falls off



7.4 Whether the contact between intermediate adapter plate is good or squeezed;

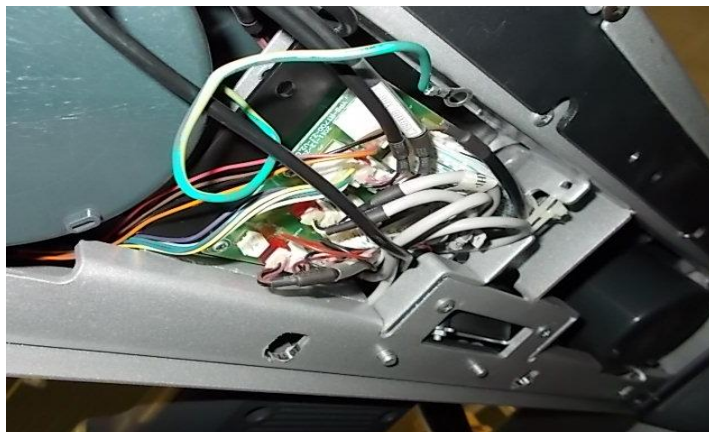

Maintenance

Fault and maintenance instructions

7.5 Check whether the console board is damaged

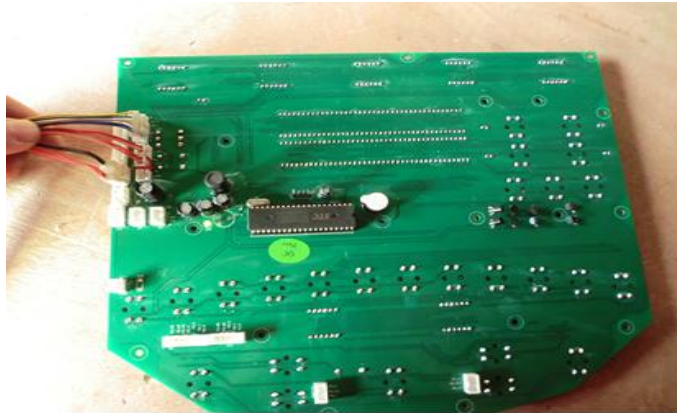

8 The console displays nothing

8.1 Check whether the power line voltage is at the normal value: AC 200-240V;



8.2 check whether the power switch on the machine is turned on



Maintenance

Fault and maintenance instructions

8.3 check whether the overcurrent switch is in the state of protection or damaged, if in protection, press slightly to return to the normal state (the state in the figure is the normal state);



8.4 check whether the contact between the upper section and lower section of console wire is good or squeezed;



8.5 Whether it is in good contact between the intermediate adapter plat or squeezed;

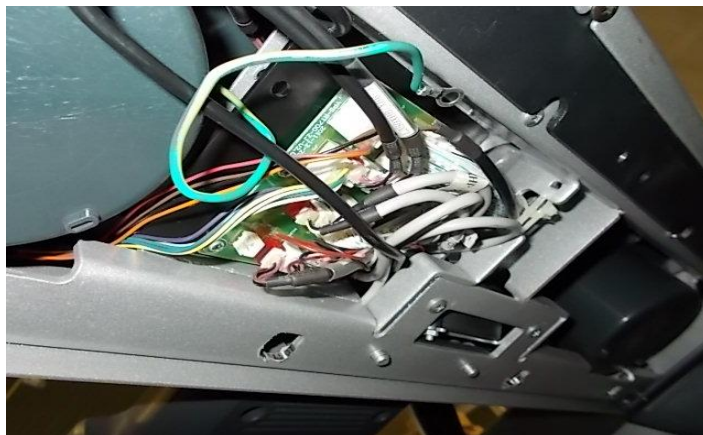

Maintenance

Fault and maintenance instructions

8.6 Check for any loosening or falling off between the console wire and the console;

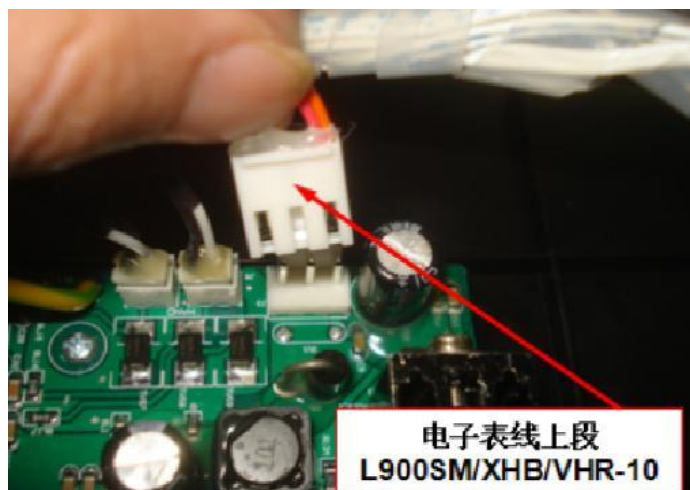

8.7 Check for any loosening or falling off between the console wire and the inverter

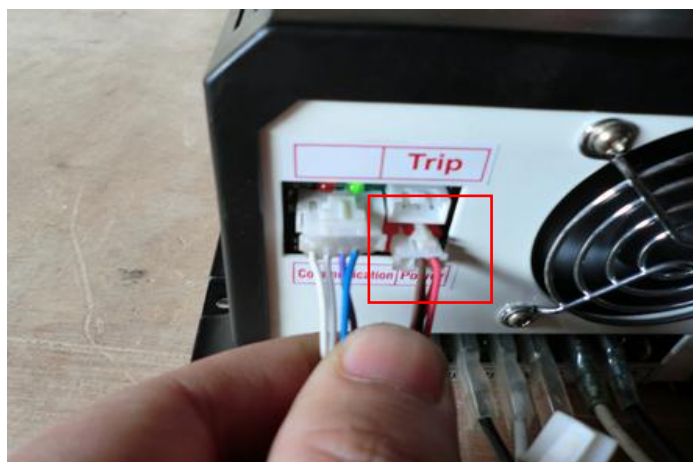

8.8 Check whether the console is damaged;

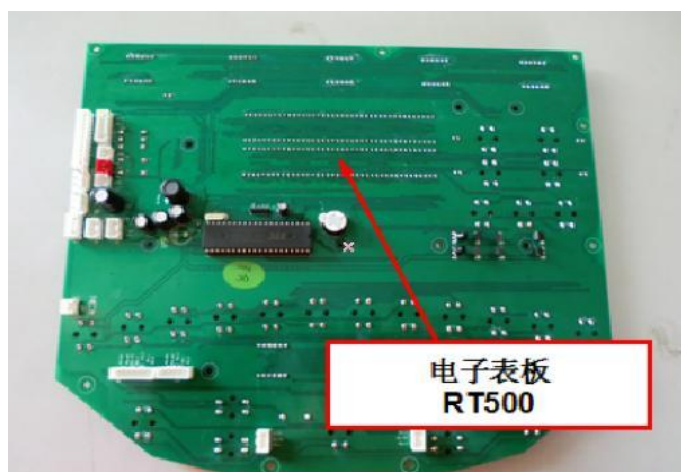

Maintenance

Fault and maintenance instructions

8.9 Check whether the inverter is damaged;



9. The console has display, but the treadmill does not start

9.1 check whether the plug of button is loose or falls off;



9.2 check whether the button is damaged;

(1).The console has displays, but there is no five-second countdown response in the lattice window of the console after pressing the start button, or there is no display of changed speed in the speed window after pressing the speed selection button, it indicates the button is damaged.

(2). The treadmill can be started, but there is no response in the angle display window of the console after pressing the angle incline + button or angle selection button, indicating the button is damaged, replace the damaged button.

Maintenance

Fault and maintenance instructions

9.3 The motor belt is loose, broken or the motor is damaged



9.4 check whether the inverter is damaged;



9.5 The intermediate adapter plate is damaged

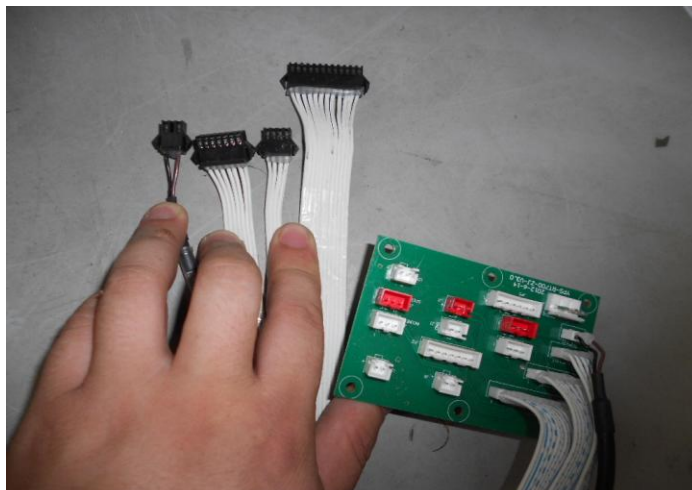

Maintenance

Fault and maintenance instructions

10.1 The console board does not supply power, the power supply of main board is normal.

Troubleshooting: Replace the backup power supply board

10.1.1 Open the case of the inverter, remove the bottom plate

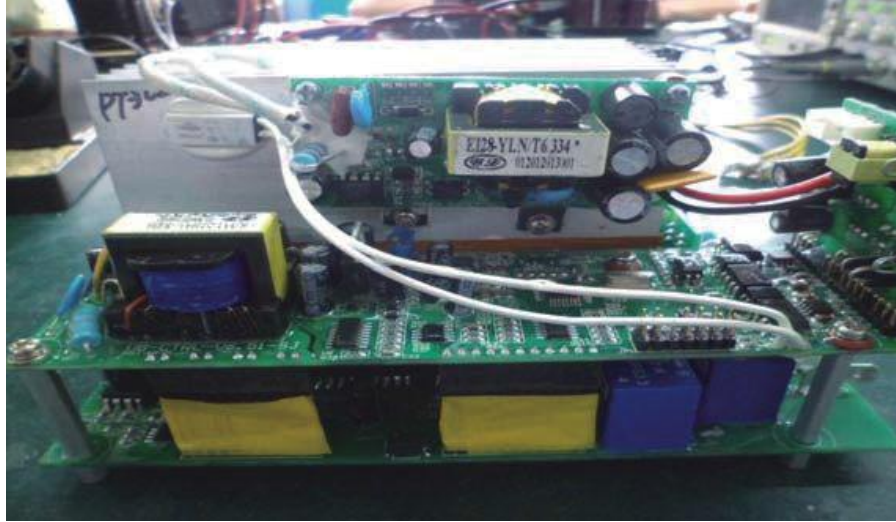

10.1.2 Use a screwdriver to remove the three anchor screws on the control board.

Screws

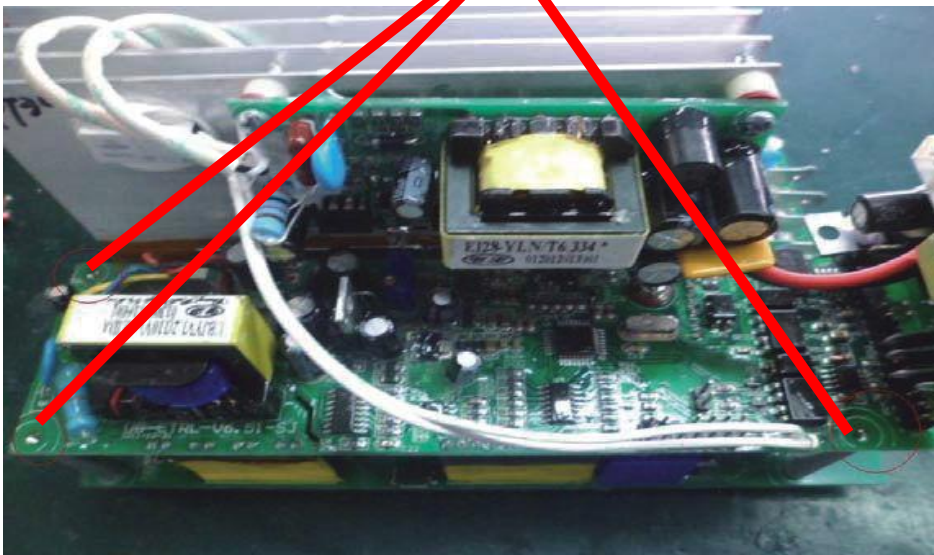

10.1.3 Remove a screw with a screwdriver to r corresponding to the bottom plate.

Maintenance

Fault and maintenance instructions

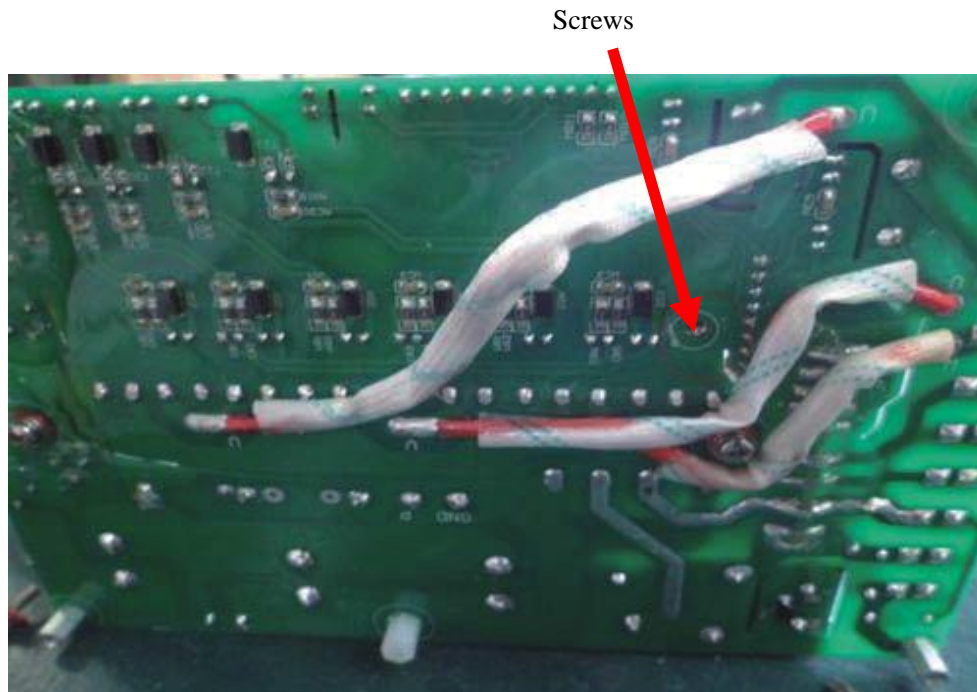

10.1.4 Open the control board, use a screwdriver to remove the four screws on the back-up power

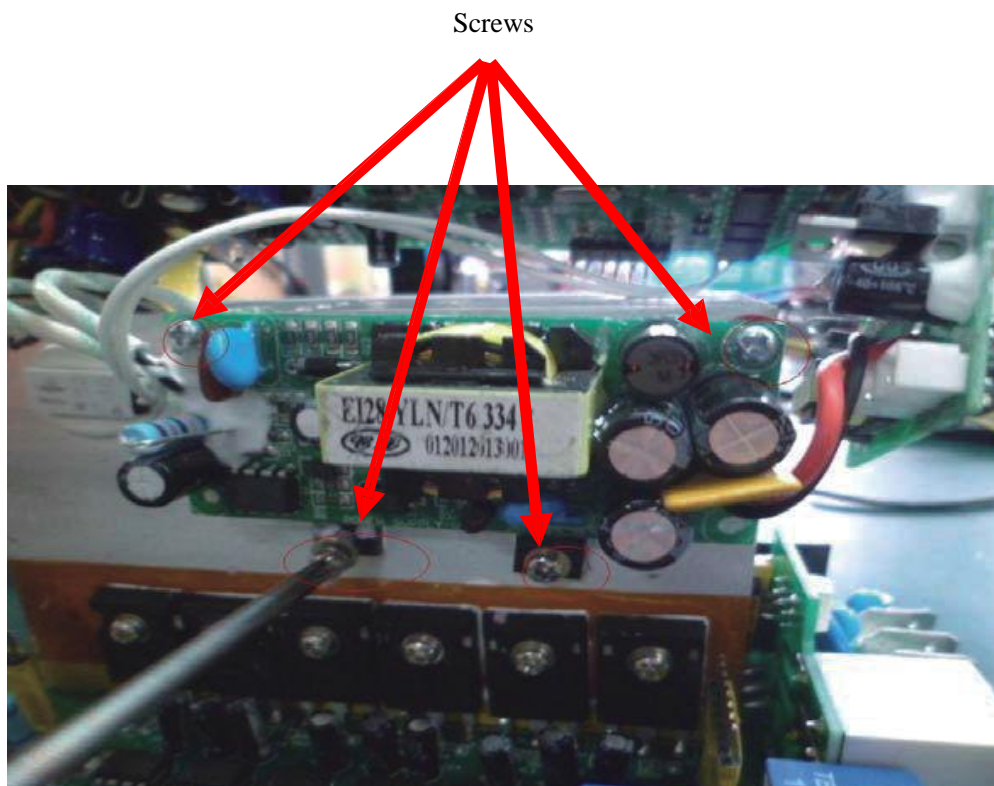

10.1.5 Remove the backup power input cable and output cable with electric iron.

Maintenance

Fault and maintenance instructions

Weld the backup power supply output cable with the electric soldering iron

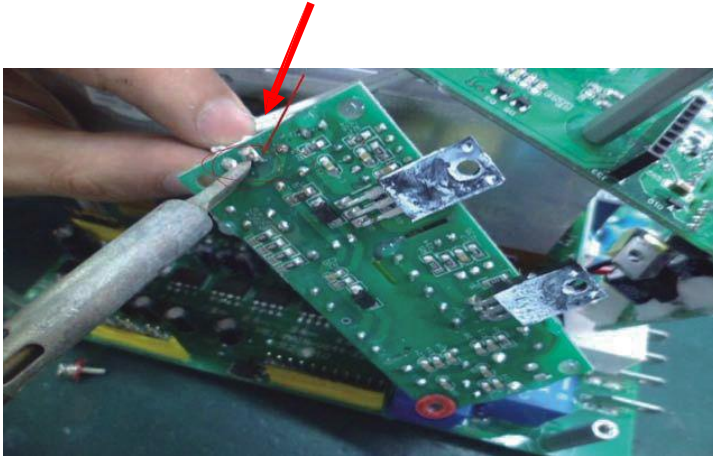

Weld the backup power supply output cable with the electric soldering iron

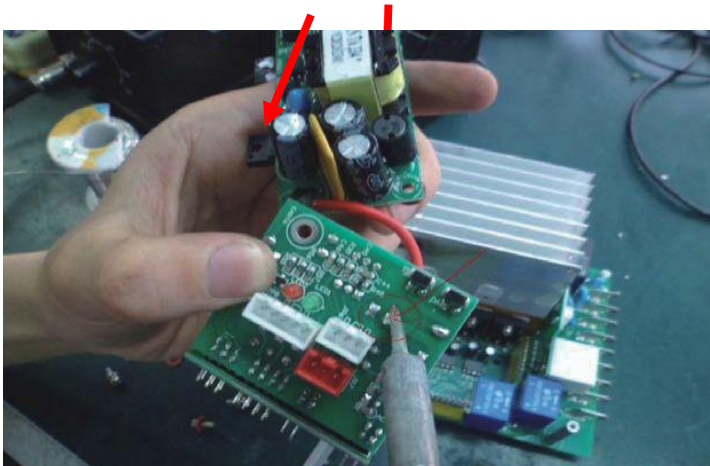

10.1.6 Remove the back-up power supply board, and install a new back-up power supply board

Weld backup power input cable

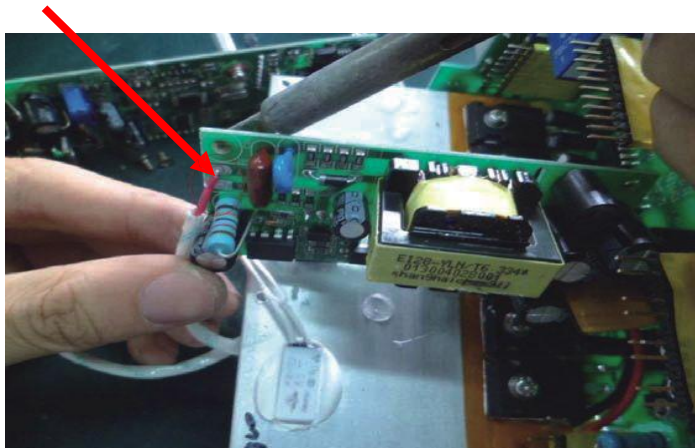

Maintenance

Fault and maintenance instructions

Weld backup power input cable

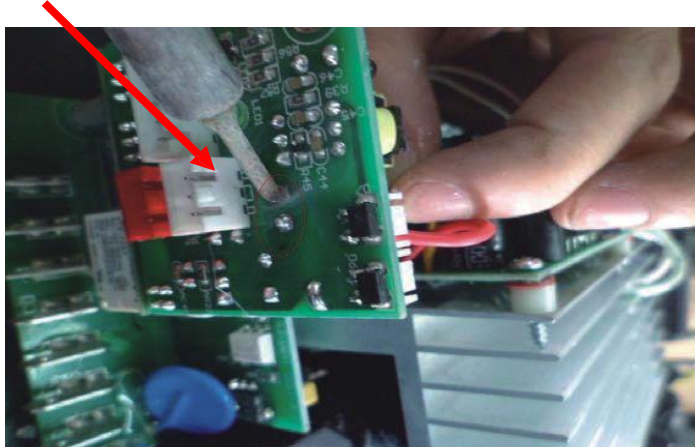

Install the screws on the backup power board

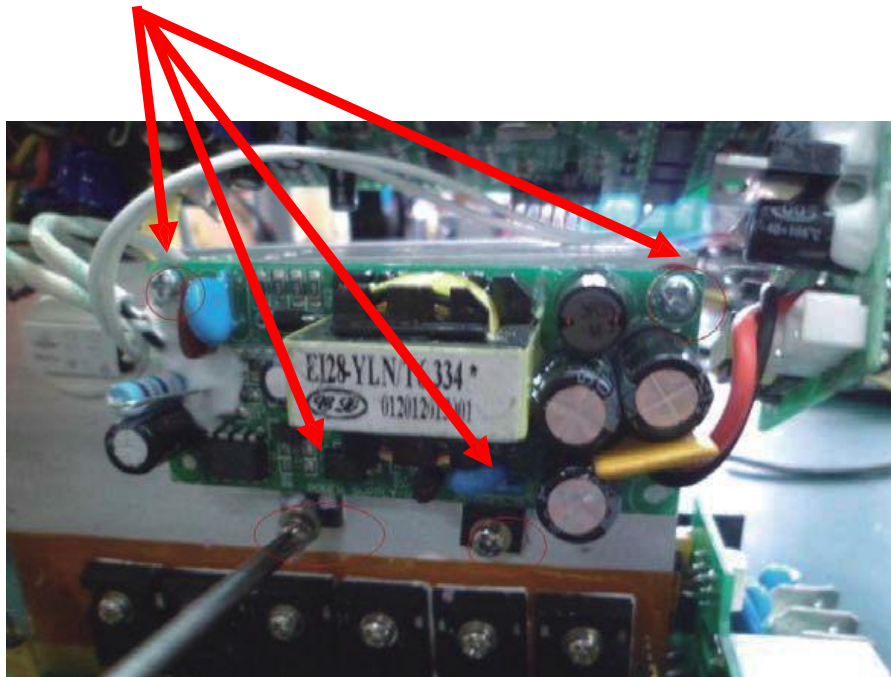

10.1.7 Install the screws of bottom plate

Maintenance

Fault and maintenance instructions

Mount the screws

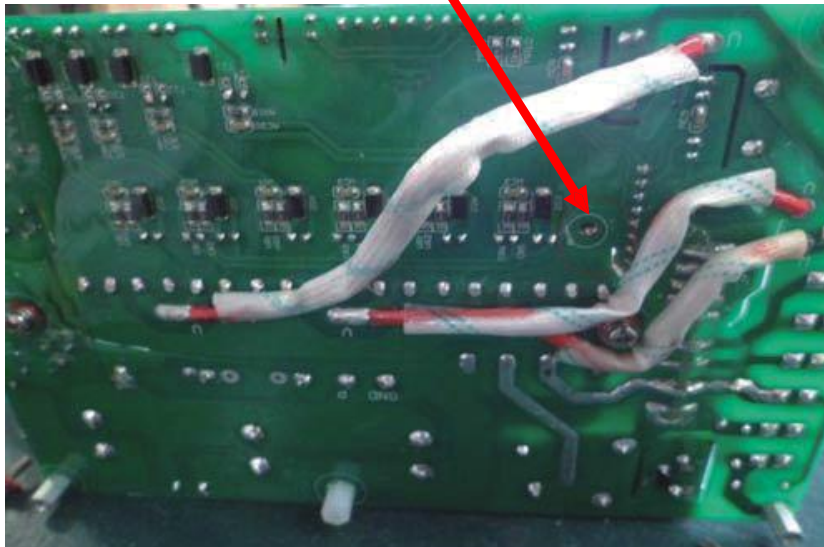

10.1.8 Install the case



10.2 Running belt jitter

Troubleshooting:

10.2.1 It needs to set parameters of the inverter to have enough torque at the low speed. Although the parameters of the inverter have been set when delivered according to the characteristics of customer's motor, due to the difference in the individual motor, the treadmill with running belt jitter needs reconfiguration of parameters. Use the debug console provided by our company with configuration #7 (torque boost factor).

Maintenance

Fault and maintenance instructions

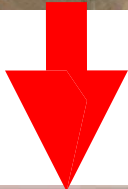

Connect the inverter



Press FREQ,
exit the setup



Press FUNC,
enter the parameter option



Press ENTER
save the settings



Press   buttons,
select the parameter options
of inverter



Press FUNC button,
enter the parameter setting



press   buttons,
adjust the default parameter values

Maintenance

Fault and maintenance instructions

10.2.2 The jitter of running board does not only occur at the low speed, or get better after the change of parameters.

Troubleshooting:

Such jitter may be caused by the 6.8V glass stabilovolt tube rupture in the machine for IGBT reverse cutoff, it needs to replace 6.8V stabilovolt tube (DZ1\DZ2\DZ3\DZU\DZV\DZW), as shown:

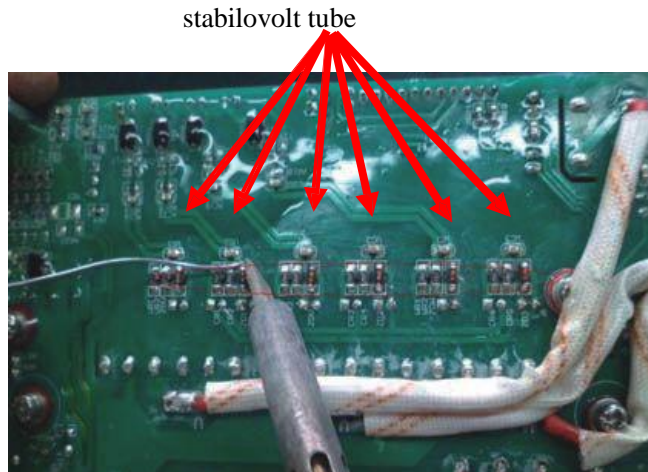

10.3 fault with incline motor



Control panel for incline

10.3.1 The incline motor raises the height to the maximum but stops at a certain distance from the minimum in the self-test. When turn it on again, the incline motor will go back to the lowest level. During the incline operation, a fault will be displayed after lowering down from the highest position. This phenomenon is commonly seen in the long-range incline motor.

Failure Analysis: because the inverter incline circuit uses optocoupler for isolation, the incline signal input end and DSP incline signal receiving end must meet the linear scale. The long-range incline motor does not reach the highest level, while the DSP detects the voltage has reached the maximum, such failure will be displayed.

Maintenance

Fault and maintenance instructions

Troubleshooting: 1. Enter the automatic calibration mode, reposition the highest and lowest points.
2. Replace the optocoupler output terminal resistor R70 (3K), as shown below:

Resistor

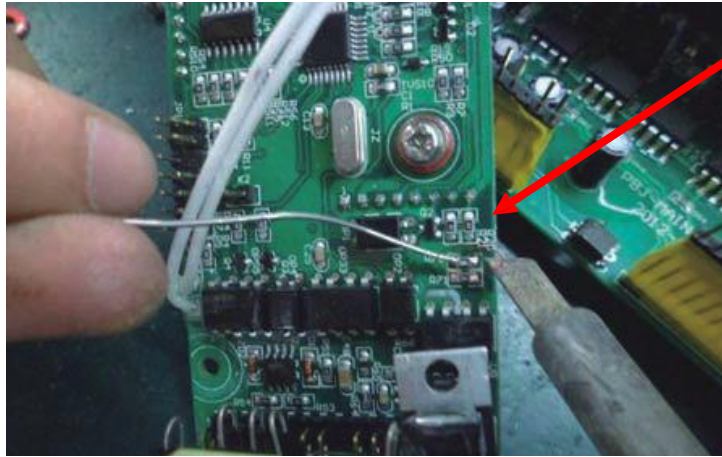

10.3.2 the incline motor stops when inclining to the highest point, and cannot lower down, the incline relay does not respond; the incline motor directly rises to the highest point in operation and cannot return to the lowest position after powered on again.

Troubleshooting:

1. Check whether the incline motor wiring is correct
2. Check whether the incline motor is stuck, if stuck, turn the spiral tube with iron rod for automatic correction again
3. Replace the incline circuit board, as shown:

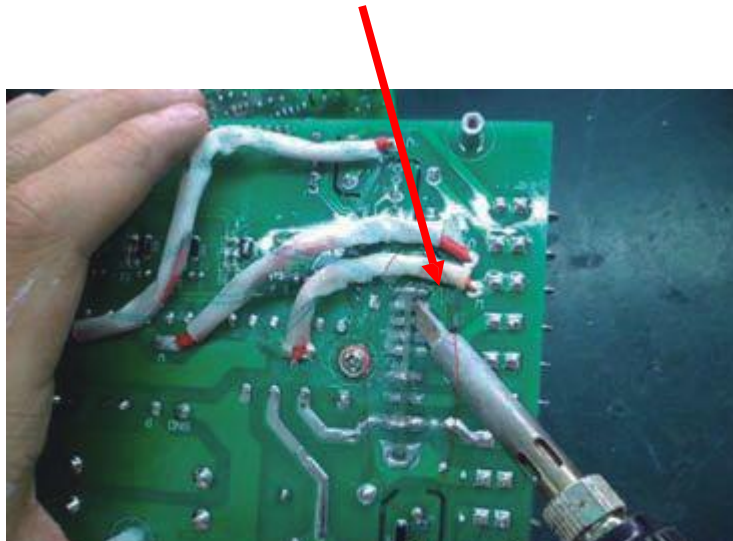

10.4 overcurrent protection (ER04)

Failure mode: the motor stops operation due to the upper control panel reporting overcurrent protection fault during running. Analysis: one or more power tube IGBT inside the inverter is damaged for breakdown. Troubleshooting: test which IGBT has breakdown with the multimeter, then replace the IGBT, as shown below:

Maintenance

Fault and maintenance instructions

IGBT



Maintenance

Equipment maintenance

Maintenance is essential for the use of treadmill, be sure to pay attention to the following maintenance methods

1. Cleaning of treadmill, regularly clean the machine and the dust under the machine. It is recommended to use soft cotton rag to brush gently, Do not use acidic detergent. Timely cleaning up the dust is helpful to cooling of the motor and the inverter, avoiding the electrical parts causing false protection (clean up once 2-3 months)

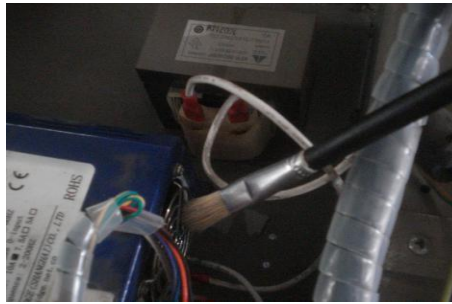

2. The use of lubricants: Impulse Health Tech Ltd adopts the conductive lubrication, which can effectively reduce the resistance between the running board and running belt, while eliminating the static electricity generated by the friction. It is recommended that the ordinary users apply lubrication between the running belt and the running board once after the machine runs for 300-500 hours.



3. Adjust the running belt, to ensure the treadmill in an optimal working state, we need to adjust the running belt to the optimum state. since the force of our left foot and right foot is not the same during running, the running belt will deviate sometimes. if running belt skewed to the right, turn the adjustment bolt on the right clockwise for 1/2 turn, and then turn the adjustment bolt on the left counterclockwise for 1/2 turn. if running belt skewed to the left, vice versa.

Note: not too tight, to avoid damaging the treadmill belt



Maintenance

Equipment maintenance

Equipment maintenance

4. Check the motor belt once every 5-6 months, if it is too loose and feels slipping in the running, appropriate adjustment is helpful to the treadmill

(1) Loosen the nut on the mounting plate of the motor. (2) Adjust screws (3) belt tension is proper

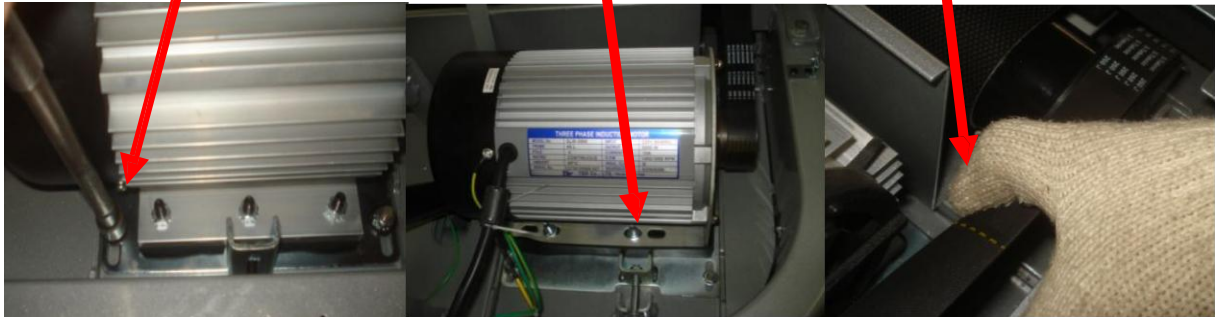

(4) After belt tension is proper, lock nut and adjusting bolt on the mounting plate of the motor

5. The wear of running belt

Two parts of the Treadmill need replacing periodically, that is, the running belt and running board, check the running belt and running board every three months to feel the bottom surface of the running belt, if it feels rough and badly worn, it is to be replaced. Continuing to run on such belt will increase the wear of running board, resulting in the wear of running board, timely replacement of running belt when it is worn will prolong the service life of the running board of your treadmill.

Replacement of main components

In the long-term use of the treadmill, some parts require regular maintenance and replacement, refer to this section for the replacement.

1 Replacement of running belt

1.1 Remove the motor cover

Remove the cross recessed pan head screw

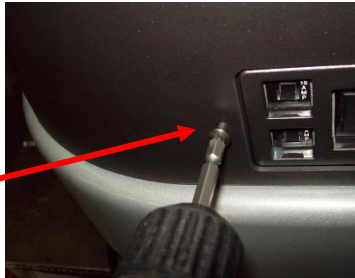

Remove the motor cover

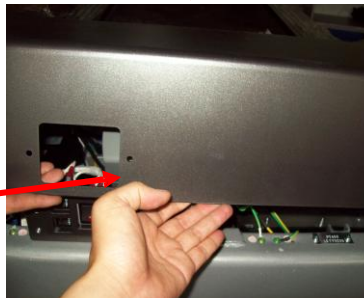

1.2 pull the ribbed belt of the motor from the pulley, turn over the ribbed belt outward with tools or by hand, while turning the motor inertia wheel to make the ribbed belt leave the belt groove

Ribbed belt

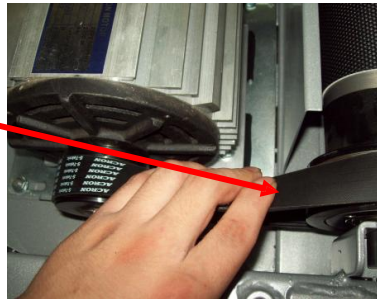

1.3 Remove the left and right end cap



Maintenance

Replacement of main components

.1.4 Remove the edge strip on the right and left



.1.5 Remove the rear wheel part

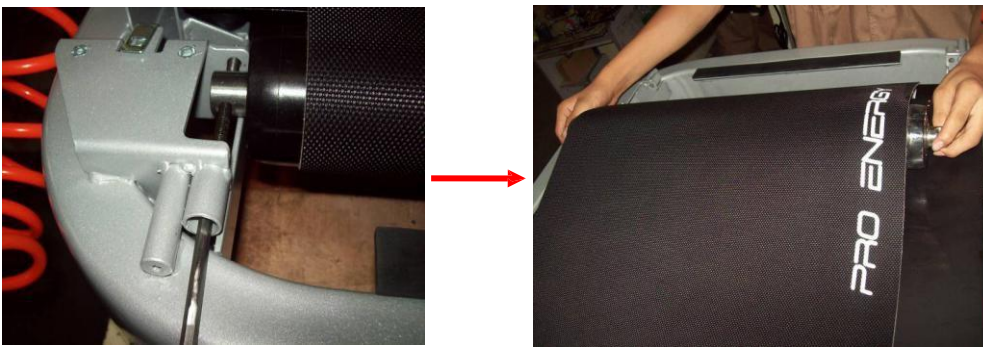

.1.6 Remove the front wheel part

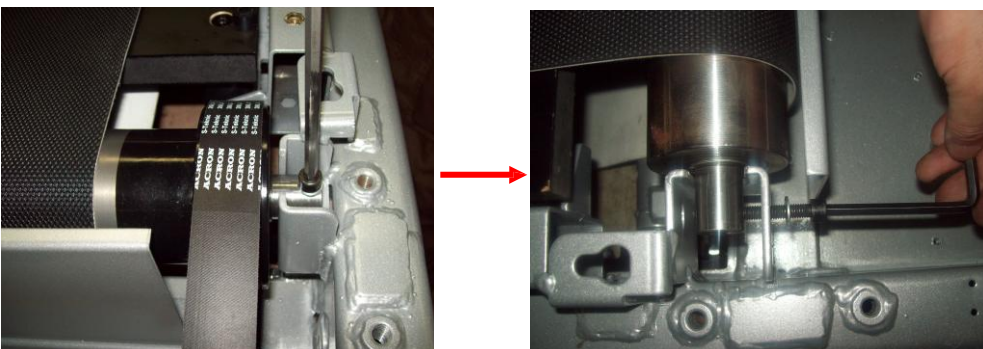

Maintenance

Replacement of main components

Remove the
front axle tube



.1.7 Remove the set screws on the running board



.1.8 Replace running belt



Lift up the running board, pull out the old running belt, place the new running belt on the running board, and align the running belt and running board

Maintenance

Replacement of main components

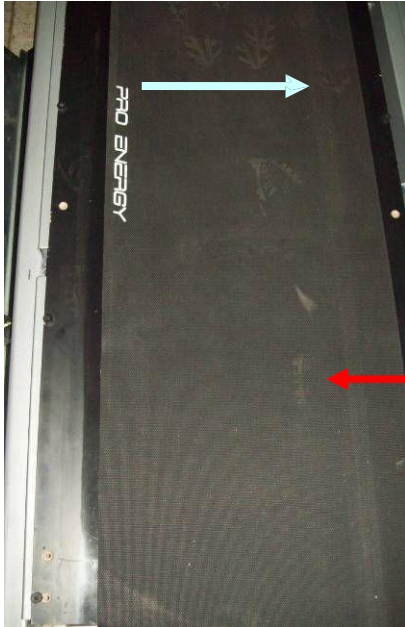

When installing the running belt, mount it from the left side as shown in the figure and move the running belt in the direction of the arrow.

.1.9 Restore: install the parts in steps reverse to the disassembly;

Step 1: Mount the mounting screws of running board

Step 2: install the front wheel parts (note to put the ribbed belt of the motor on the front wheel parts)

Step 3: Install the rear wheel parts

Step 4: Install the edge strip on both sides

Step 5: Install the end cap on both sides

Step 6: Put the ribbed belt of the motor on the pulley and the motor belt groove

Step 7: Mount the motor cover

.1.10 adjust and tighten the treadmill belt after powered on



Use 6 # socket head wrench to adjust the treadmill belt tightness to ensure the belt to be in the center, during the process of running, if the belt deviates to the left, use the socket head wrench to turn the adjusting points clockwise for adjustment on the rear left side, if running belt skewed to the right, use the socket head wrench to turn the adjusting points clockwise for adjustment on the rear right side, until the running belt tension is proper and centered for long.

Maintenance

Replacement of main components

2 Replacement of wedge belt

2.1 Remove the motor cover



Remove the cross pan head screw



remove the motor cover

.2.2 pull the motor ribbed belt from the pulley



ribbed belt

Note: turn over the ribbed belt outward with tools or by hand, while turning the motor inertia wheel to make the ribbed belt leave the belt groove

.2.3 adjust the rear wheel parts counterclockwise to loosen the running belt



Use 6 # socket head wrench to adjust the running belt tightness counterclockwise, loosening the running belt

Maintenance

Replacement of main components

.2.4 Remove the front wheel parts to remove the ribbed belt

Allen wrench

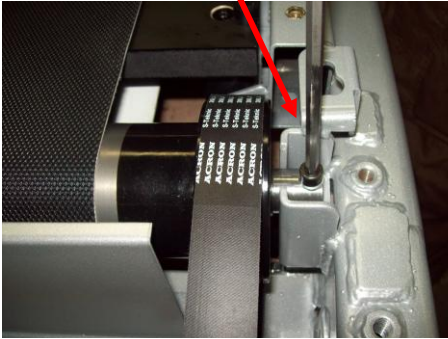

front wheel parts

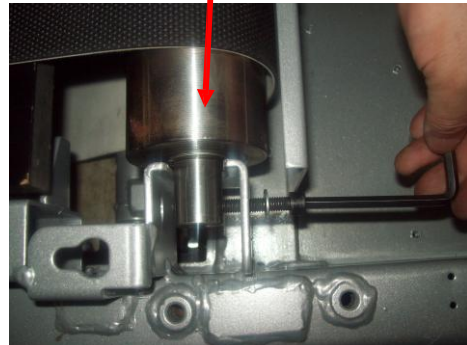

Remove the front axle tube

.2.5 put a new ribbed belt on the front wheel assembly and install it in its original position

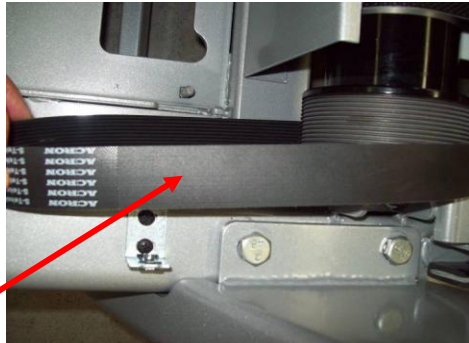

Before putting the front wheel assembly in its original position, be sure to put the ribbed belt on the new front axle tube

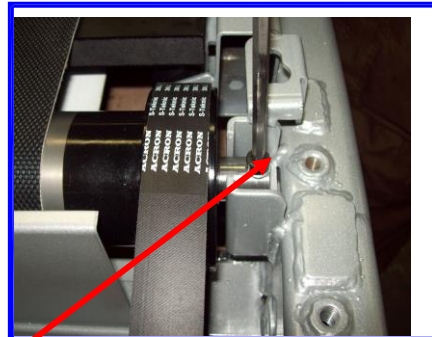

Allen wrench

Maintenance

Replacement of main components

2.6 Restore: install the parts in steps reverse to the disassembly;

Step 1: Tighten mounting bolts on the rear wheel parts

Step 2: put the ribbed belt of the motor on the pulley and the motor belt groove

Step 3: install the motor cover

Step 4: adjust and tighten the treadmill belt after powered on

.3 Replace the belt drive motor

.3.1 Remove the motor cover



Remove the Phillips pan head screws remove the motor cover

.3.2 pull the ribbed belt of the motor from the pulley



ribbed
belt

Note: turn over the ribbed belt outward with tools or by hand, while turning the motor inertia wheel to make the ribbed belt leave the belt groove

.3.3 remove the motor bolts and flange nuts



Remove the hex bolt counterclockwise with a fork wrench

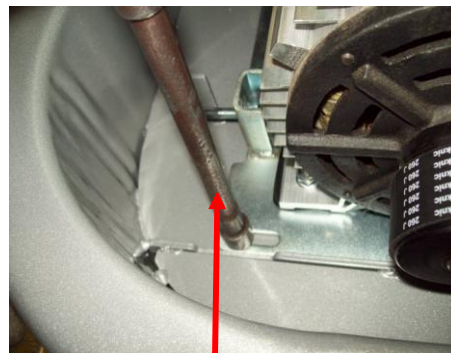

remove the hex flange nut counterclockwise with a socket wrench

Maintenance

Replacement of main components

.3.4 Unplug electrical motor cable

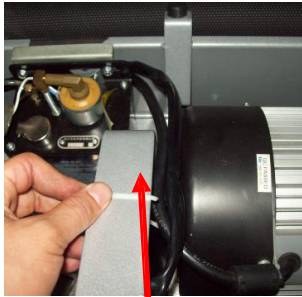

Cut off the cable tie and the cable holder fixing the motor connections with diagonal pliers

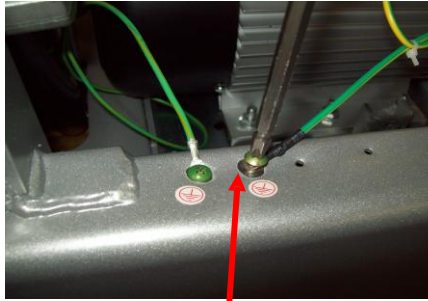

Remove the grounding screw of the motor with Phillips screwdriver



Remove the plug of the motor on the controller

.3.5 Replace the motor



Remove the old motor, and put the new motor in its original position

.3.6 Restore: install the parts in steps reverse to the disassembly;

Step 1: Mount the motor grounding screw on the deck frame, put plug in the controller, fix the cable tie and cable holder for connections on the deck frame.

Step 2: Mount the motor bolt and flange nut

Step 3: Put the ribbed belt of the motor on the pulley and motor belt groove, adjust the motor drive bolt according to the tightness of ribbed belt, and finally tighten the flange nuts

Step 4: Install the motor cover

4 Replacement of incline motor

.4.1 Remove the motor cover



Remove the Phillips pan head screws



remove the motor cover

.4.2 Remove the connecting bolt of incline motor and the deck frame



Remove the hex bolt and nut connecting the incline motor and deck frame with a wrench

.4.3 remove the connecting bolt between incline motor and the incline frame

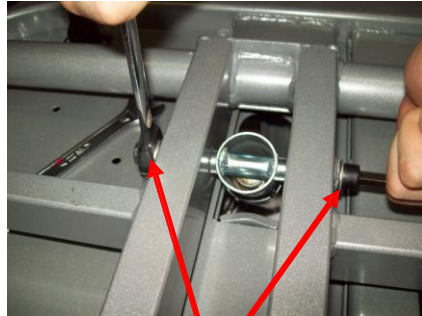

Raise the deck frame, and remove the cheese head hex bolts and nuts connecting the incline motor and the incline frame

.4.4 Disconnect the incline motor cable

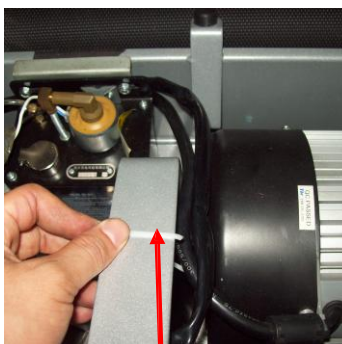

Cut off the cable tie and the cable holder fixing the motor connections with diagonal pliers

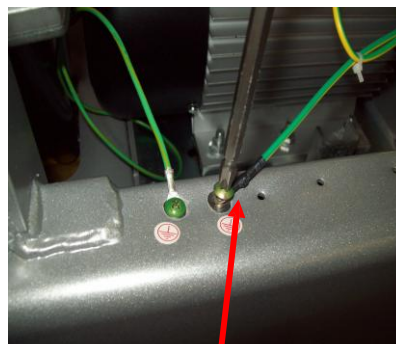

Remove the grounding screw of the motor with Phillips screwdriver

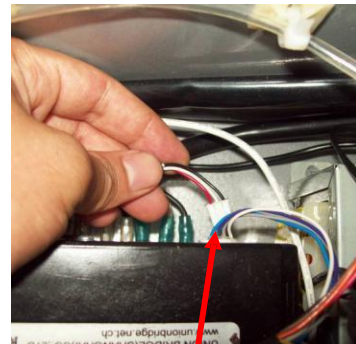

Remove the plug of the motor on the controller

.4.5 Replace the incline motor

Maintenance

Replacement of main components

incline
motor

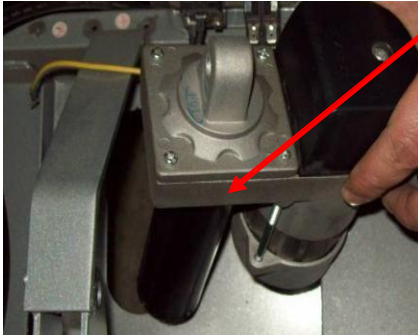

Remove the old incline motor, the new incline motor mounted in the original position

.4.6 Restore: install the parts in steps reverse to the disassembly;

Step 1: Mount the motor grounding screw on the deck frame, put plug in the controller, fix the cable tie and cable holder for connections on the deck frame.

Step 2: Tighten the connecting bolt between the incline motor and the incline frame

Step 3: Mount and tighten the connecting bolt between the incline motor and the deck frame

Step 4: Install the motor cover

5 Replacement of front wheel assembly, for replacement steps of front wheel components, please refer to the operation instruction for front wheel in the replacement of treadmill belt, as follows:

1. Remove the motor cover
2. Pull the motor belt from the pulley
3. Loosen the rear axle tube
4. Remove the old front axle tube
5. Put the new front axle tube on the motor belt, and place in the original position
6. Restore to the original condition

6 Replacement of rear wheel assembly, for replacement steps of rear wheel components, please refer to the operation instruction for rear wheel in the replacement of treadmill belt, as follows:

1. Remove the end cap on both sides
2. Remove the mounting screws of rear axle tube, remove the old rear axle tube
3. Put the new axle tube in the original position
4. Restore to the original condition
5. Adjust and tighten the running belt

Maintenance

Replacement of main components

7 Replacement of console board

1. Remove the four self-tapping screws behind the console
2. Open the console assembly

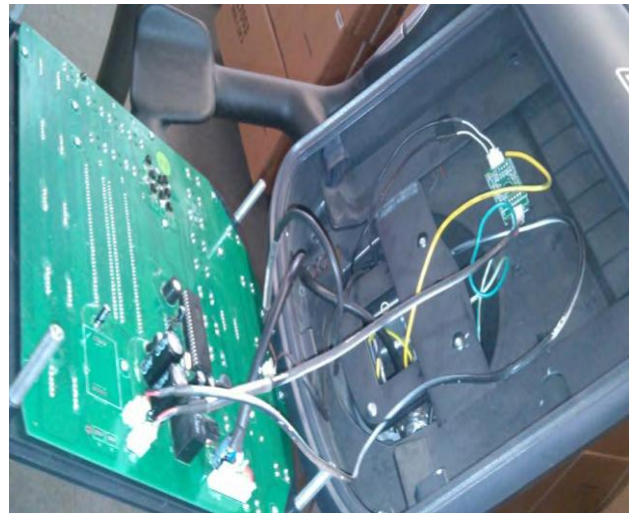

3. Remove the self-tapping screws on the circuit board, replace the console and restore to its original condition

